

User Manual

020-001466-05

# Christie HS Series 2K

D13HD2-HS, D13WU2-HS, D16HD-HS

D16WU-HS, D20HD-HS, D20WU-HS

**CHRISTIE®**

## NOTICES

### COPYRIGHT AND TRADEMARKS

Copyright ©2020 Christie Digital Systems USA Inc. All rights reserved.

All brand names and product names are trademarks, registered trademarks or trade names of their respective holders.

### GENERAL

Every effort has been made to ensure accuracy, however in some cases changes in the products or availability could occur which may not be reflected in this document. Christie reserves the right to make changes to specifications at any time without notice. Performance specifications are typical, but may vary depending on conditions beyond Christie's control such as maintenance of the product in proper working conditions. Performance specifications are based on information available at the time of printing. Christie makes no warranty of any kind with regard to this material, including, but not limited to, implied warranties of fitness for a particular purpose. Christie will not be liable for errors contained herein or for incidental or consequential damages in connection with the performance or use of this material. Canadian manufacturing facility is ISO 9001 and 14001 certified.

### WARRANTY

Products are warranted under Christie's standard limited warranty, the complete details of which are available by contacting your Christie dealer or Christie. In addition to the other limitations that may be specified in Christie's standard limited warranty and, to the extent relevant or applicable to your product, the warranty does not cover:

- a. Problems or damage occurring during shipment, in either direction.
- b. Problems or damage caused by combination of a product with non-Christie equipment, such as distribution systems, cameras, DVD players, etc., or use of a product with any non-Christie interface device.
- c. Problems or damage caused by misuse, improper power source, accident, fire, flood, lightning, earthquake, or other natural disaster.
- d. Problems or damage caused by improper installation/alignment, or by equipment modification, if by other than Christie service personnel or a Christie authorized repair service provider.
- e. Problems or damage caused by use of a product on a motion platform or other movable device where such product has not been designed, modified or approved by Christie for such use.
- f. Except where the product is designed for outdoor use, problems or damage caused by use of the product outdoors unless such product is protected from precipitation or other adverse weather or environmental conditions and the ambient temperature is within the recommended ambient temperature set forth in the specifications for such product.
- g. Defects caused by normal wear and tear or otherwise due to normal aging of a product.

The warranty does not apply to any product where the serial number has been removed or obliterated. The warranty also does not apply to any product sold by a reseller to an end user outside of the country where the reseller is located unless (i) Christie has an office in the country where the end user is located or (ii) the required international warranty fee has been paid.

The warranty does not obligate Christie to provide any on site warranty service at the product site location.

### PREVENTATIVE MAINTENANCE

Preventative maintenance is an important part of the continued and proper operation of your product. Failure to perform maintenance as required, and in accordance with the maintenance schedule specified by Christie, will void the warranty.

### REGULATORY

The product has been tested and found to comply with the limits for a Class A digital device, pursuant to Part 15 of the FCC Rules. These limits are designed to provide reasonable protection against harmful interference when the product is operated in a commercial environment. The product generates, uses, and can radiate radio frequency energy and, if not installed and used in accordance with the instruction manual, may cause harmful interference to radio communications. Operation of the product in a residential area is likely to cause harmful interference in which case the user will be required to correct the interference at the user's own expense.

### CAN ICES-3 (A)/NMB-3 (A)

이 기기는 업무용 (A 급) 으로 전자파적합등록을 한 기기이오니 판매자 또는 사용자는 이점을 주의하시기 바라며, 가정 외의 지역에서 사용하는 것을 목적으로 합니다.

### ENVIRONMENTAL

The product is designed and manufactured with high-quality materials and components that can be recycled and reused. This symbol  means that electrical and electronic equipment, at their end-of-life, should be disposed of separately from regular waste. Please dispose of the product appropriately and according to local regulations. In the European Union, there are separate collection systems for used electrical and electronic products. Please help us to conserve the environment we live in!

# Content

- Introduction ..... 8**
  - Safety and warning guidelines ..... 8
    - AC/power precautions ..... 9
    - Installation safety and warning guidelines ..... 9
    - Laser safety precautions ..... 9
    - Light intensity hazard distance ..... 10
    - Product labels ..... 12
  - Projector overview ..... 14
  - Contact your dealer ..... 14
  - Key features ..... 14
  - How the projector works ..... 15
  - List of components ..... 15
  - Product documentation ..... 16
    - Related documentation ..... 16
  - Site requirements ..... 17
    - Physical operating environment ..... 17
    - Power connection ..... 17
  - Projector components ..... 18
    - Front view ..... 18
    - Rear view ..... 18
    - Left view ..... 19
    - Right view ..... 19
  - Built-in keypad ..... 20
  - Input/output (I/O) panel ..... 21
  - IR remote keypad ..... 22
  - Turning on the projector ..... 24
  - Turning off the projector ..... 24
  - LED status indicator ..... 25
    - Status LED ..... 25
    - Shutter LED ..... 25
- Adjusting the size and position ..... 26**
  - Setting the image size preset ..... 26
  - Adjusting pixel phase ..... 27

- Setting the position of display image . . . . . 27
- Setting the digital size of display image . . . . . 27
- Setting the digital position of display image . . . . . 27
- Geometry correction . . . . . 28
  - Saving geometry correction . . . . . 28
  - Applying geometry correction . . . . . 28
  - Adjusting horizontal keystone . . . . . 28
  - Adjusting the vertical keystone . . . . . 29
  - Adjusting horizontal pincushion . . . . . 29
  - Adjusting vertical pincushion . . . . . 29
  - Adjusting 4-corner . . . . . 30
  - Enabling auto warp filter . . . . . 30
  - Adjusting warp filter . . . . . 30
  - Resetting geometry correction setting . . . . . 30
- Configuring warp and blend . . . . . 31
  - Warping an image . . . . . 31
  - Downloading a warp from the projector memory . . . . . 31
  - Enabling basic image blending . . . . . 32
  - Blending multiple images . . . . . 32
  - Downloading a blend from the projector memory . . . . . 33
  - Performing auto warp and blend . . . . . 33
- Adjusting the image settings . . . . . 34**
  - Adjusting the brightness . . . . . 34
  - Adjusting the contrast . . . . . 34
  - Adjusting the color space . . . . . 34
  - Adjusting the image sharpness . . . . . 35
  - Setting up 3D display . . . . . 35
    - Setting 3D format . . . . . 35
    - Inverting 3D signal . . . . . 36
    - Setting the 3D sync output signal . . . . . 36
    - Setting the frame delay . . . . . 36
    - Setting the left/right (L/R) reference . . . . . 36
  - Configuring the video settings . . . . . 37
    - Adjusting black and white video . . . . . 37
    - Adjusting the color balance . . . . . 37
    - Adjusting the skin color . . . . . 37
    - Reducing the temporal noise . . . . . 37
    - Reducing the MPEG noise . . . . . 37

- Setting the input levels ..... 38
  - Adjusting the color gain ..... 38
  - Adjusting the color offset ..... 38
  - Syncing the input signal ..... 38
  - Resetting the input levels ..... 39
- Configuring picture settings ..... 39
- Saving customized picture setting ..... 39
- Setting the contrast ratio ..... 40
- Setting up the Dynamic Black ..... 40
- Enabling the image freeze ..... 41
- Adjust the color of the image ..... 41
  - Adjusting primary colors ..... 41
  - Setting the wall color ..... 42
- Adjusting the color value based on gamma setting ..... 43
- Adjusting the white peaking ..... 43
- Adjusting the color temperature ..... 43
- Adjusting the color wheel speed ..... 43
- Setting the Real Black threshold ..... 44
- Configuring the HDMI setting ..... 44
- Configuring system settings ..... 45**
  - Changing the language ..... 45
  - Adjusting lens settings ..... 45
    - Viewing the lens type ..... 45
    - Aligning the image with zoom and focus ..... 46
    - Adjusting lens position ..... 46
    - Saving lens setting ..... 46
    - Applying the previous lens setting ..... 46
    - Locking the lens motor ..... 47
    - Resetting the lens to home position ..... 47
  - Selecting screen image orientation ..... 47
  - Adjusting on-screen display menus ..... 48
    - Determining the on-screen display position ..... 48
    - Setting the transparency of the on-screen display position ..... 48
    - Setting time out for on-screen display ..... 48
  - Showing Messages ..... 48
  - Changing the splash screen ..... 49
  - Setting up password protection ..... 49
  - Changing password ..... 49

Setting up power mode . . . . .	50
Setting the standby mode . . . . .	50
Setting the AC power . . . . .	50
Setting the time for auto shutdown . . . . .	50
Setting the sleep timer . . . . .	50
Enabling the 12V Trigger . . . . .	51
Enabling high altitude setting . . . . .	51
Adjusting the back light settings . . . . .	51
Setting the hot key . . . . .	51
<b>Configuring communications . . . . .</b>	<b>53</b>
Setting the projector communication . . . . .	53
Setting network environment . . . . .	54
Adjusting LAN setting . . . . .	54
Adjusting WLAN setting . . . . .	54
Adjusting network setting . . . . .	55
Setting serial port baud rate . . . . .	55
Enabling serial port echo . . . . .	55
Setting serial port path . . . . .	55
Using web user interface . . . . .	56
System requirements . . . . .	56
Logging on to the web user interface . . . . .	56
Setting the system notification . . . . .	57
<b>Configuring input settings . . . . .</b>	<b>58</b>
Setting main input source . . . . .	58
Setting second input source . . . . .	58
Enabling second input source . . . . .	58
Swapping main input and second input source . . . . .	58
Setting the size of second input source . . . . .	59
Setting up the display layout with two input sources . . . . .	59
Input sources layout and size . . . . .	59
Setting the timing detection mode . . . . .	60
Setting the input searching method . . . . .	60
Blanking the screen for signal switch . . . . .	60
<b>Configuring light settings . . . . .</b>	<b>61</b>
Setting light source mode . . . . .	61
Adjusting the light power . . . . .	62

Calibrating the light sensor . . . . .	62
<b>Diagnostic tools . . . . .</b>	<b>63</b>
Viewing projector information . . . . .	63
Selecting a test pattern . . . . .	63
Restoring factory default settings . . . . .	64
<b>Signal connectivity specifications . . . . .</b>	<b>65</b>
VGA video formats . . . . .	65
HDMI video formats . . . . .	66
DVI video formats . . . . .	67
HDBaseT video formats . . . . .	69
3G-SDI video formats . . . . .	70
Picture-in-picture/picture-by-picture (PIP/PBP) compatibility . . . . .	71
<b>Regulatory . . . . .</b>	<b>72</b>
Safety . . . . .	72
Laser safety . . . . .	72
Electro-magnetic compatibility . . . . .	72
Emissions . . . . .	72
Immunity . . . . .	72
Environmental . . . . .	73

# Introduction

This manual is intended for Christie qualified installers and trained operators of HS Series 2K projectors—D13HD2-HS, D13WU2-HS, D16HD-HS, D16WU-HS, D20HD-HS, and D20WU-HS.

For complete HS Series 2K product documentation and technical support, go to [www.christiedigital.com](http://www.christiedigital.com).

## Safety and warning guidelines

Read all safety and warning guidelines before installing or operating the projector. This projector must be operated in an environment that meets the operating range specification. Use only the attachments and/or accessories recommended by Christie. Use of others may result in the risk of fire, shock, or personal injury. This projector is intended for use in a non-cinema environment.



**Warning!** If not avoided, the following could result in death or serious injury.

- Do not expose the product to moisture.
- Do not operate the product without all of its covers in place.
- This product must be installed within a restricted access location not accessible by the general public.
- Only personnel who are trained on the precautions for the restricted access location can be granted entry to the area.
- FIRE HAZARD! Keep hands, clothes, and all combustible material away from the concentrated light beam of the projector.
- TRIP OR FIRE HAZARD! Position all cables where they cannot contact hot surfaces, be pulled, be tripped over, or damaged by persons walking on or objects rolling over the cables.
- SHOCK HAZARD! Disconnect the product from AC before installing, moving, servicing, cleaning, removing components, or opening any enclosure.
- A minimum of four people or appropriately rated lift equipment is required to safely lift, install, or move the product.
- OPTICAL RADIATION HAZARD! Disconnect the power plug from the AC outlet if the product is not being used for an extended period of time.
- Do not allow anything to rest on the power cord.
- Always provide proper ventilation for the product to prevent overheating.



**Caution!** If not avoided, the following could result in minor or moderate injury.

- Only Christie qualified technicians are permitted to open product enclosures.
- All procedures must be performed by Christie qualified technicians.



**Notice.** If not avoided, the following may result in equipment or property damage.

- Always use a lens plug when installing or moving the product. This prevents contaminants from entering the product.
- Only use cleaning solutions recommended by Christie. All other cleaning solutions may cause product damage and will void the warranty.



## AC/power precautions

Read all AC/power precautions before installing or operating the projector.



**Warning!** If not avoided, the following could result in death or serious injury.

- FIRE HAZARD! Do not use a power cord, harness, or cable that appears damaged.
- FIRE OR SHOCK HAZARD! Do not overload power outlets and extension cords.
- SHOCK HAZARD! Only use the AC power cord provided with the product or recommended by Christie.
- FIRE AND SHOCK HAZARD! Do not attempt operation unless the power cord, power socket, and power plug meet the appropriate local rating standards.
- SHOCK HAZARD! Do not attempt operation if the AC supply is not within the specified voltage and current, as specified on the license label.
- SHOCK HAZARD! The AC power cord must be inserted into an outlet with grounding.
- SHOCK HAZARD! Disconnect the product from AC before installing, moving, servicing, cleaning, removing components, or opening any enclosure.
- Install the product near an easily accessible AC receptacle.

## Installation safety and warning guidelines

Read all installation safety and warning guidelines before installing the projector.



**Warning!** If not avoided, the following could result in death or serious injury.

- High leakage current present when connected to IT power systems.



**Caution!** If not avoided, the following could result in minor or moderate injury.

- ELECTRICAL and BURN HAZARD! Use caution when accessing internal components.
- Only Christie qualified technicians are authorized to use the tools provided in the toolbox.

## Laser safety precautions

This projector has been classified as Class 1 Laser Product-Risk Group 3 according to the IEC 60825-1:2014 and IEC 62471-5:2015 standard. Read all safety and warning guidelines before installing or operating the projector.



**Warning!** If not avoided, the following could result in death or serious injury.

- PERMANENT/TEMPORARY BLINDNESS HAZARD! No direct exposure to the beam must be permitted.
- LASER RADIATION HAZARD! This projector has a built-in Class 4 laser module. Never attempt to disassemble or modify the laser module.
- Possibly hazardous optical radiation emitted from this product.
- Only Christie qualified technicians who are knowledgeable about the hazards associated with laser use, high-voltage, and high temperatures generated by the product are authorized to assemble, install, and service the Christie Laser Projection System.
- Do not look directly into the lens when the light source is on. The extremely high brightness can cause permanent eye damage.
- Do not operate the product without all of its covers in place.

## Light intensity hazard distance

This projector has been classified as Risk Group 3 according to the IEC 62471-5:2015 standard due to possible hazardous optical and thermal radiation being emitted.



**Warning!** If not avoided, the following could result in death or serious injury.

- PERMANENT/TEMPORARY BLINDNESS HAZARD! No direct exposure to the beam must be permitted.
- PERMANENT/TEMPORARY BLINDNESS HAZARD! Operators must control access to the beam within the hazard distance or install the product preventing potential exposure of the spectators' eyes from being in the hazard distance. Hazard zone shall be no lower than 3.0 meters above the floor. In addition, horizontal clearance to the hazard zone shall be a minimum 2.5 meters.
- EXTREME BRIGHTNESS! Do not place reflective objects in the product light path.

The following diagram shows the zones for optical and skin hazard distances:

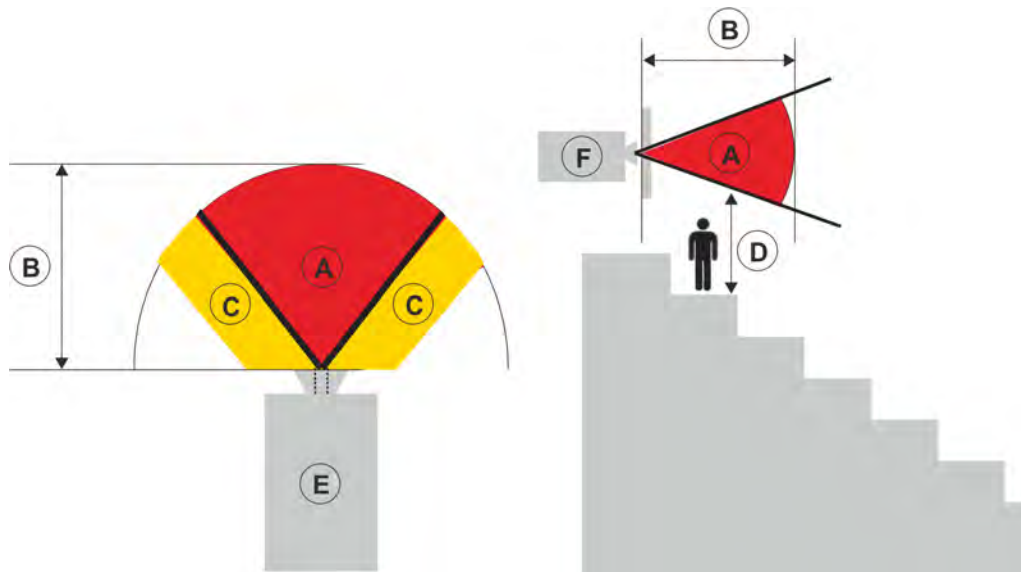

- A—Hazard zone. The region of space where the projection light from the laser illuminated projector is above emission limits for Risk Group 2. The light intensity may cause eye damage after a momentary or brief exposure (before a person can avert his or her eyes away from the light source). The light may cause skin burns to occur.
- B—Hazard distance. Operators must control access to the beam within the hazard distance or install the product preventing potential exposure of the spectators' eyes from being in the hazard distance.
- C—No access zone. Horizontal clearance of the no access zone shall be a minimum of 2.5 meters.
- D—Vertical distance to hazard zone. The hazard zone shall be no lower than 3.0 meters above the floor.
- E—Represents the top view of the projector.
- F—Represents the side view of the projector.

The following table lists the hazard distance for the Christie projector lens with the zoom adjusted to its most hazardous position.

US and International hazard distances based upon IEC 62471-5:2015, *Photobiological safety of lamps and lamp systems – Part 5: Image projectors*:

Projection lens	Part number	Hazard distance (m)
0.38:1 ultra short throw lens	140-142108-XX	1.0
0.84-1.02:1 zoom lens	140-114107-XX	1.0
1.02-1.36:1 zoom lens	140-115108-XX	1.0
1.2-1.5:1 zoom lens	140-109101-XX	1.0
1.5-2.0:1 zoom lens	140-110103-XX	1.0
2.0-4.0:1 zoom lens	140-111104-XX	1.0
4.0-7.2:1 zoom lens	140-116109-XX	1.6

### For installations in the United States

The following must be in place for laser-illuminated projector installations in the United States:



- Any human access to the hazard zone, if applicable, must be restricted by barriers to enforce the no access zone.
- Permanent show installations containing Risk Group 3 laser-illuminated projectors must meet the following conditions:
  - Installed by Christie or by Christie-authorized and trained installers. Refer to the Laser Illuminated Projector-Class 1 Risk Group 3 Installation training (Course code: CF-LIPI-01) on the <http://www.christieuniversity.com> site.
  - Performed according to instructions provided by Christie.
  - Ensure the projection system is securely mounted or immobilized to prevent unintended movement or misalignment of the projections.
- Temporary show installations containing Risk Group 3 laser-illuminated projectors may be installed by Christie or sold or leased only to valid laser light show variance holders (laser light show manufacturers) for image projection applications. Such manufacturers may currently hold a valid variance for production of Class IIIb and IV laser light shows and/or for incorporation of the Risk Group 3 laser-illuminated projectors into their shows. This requirement applies also to dealers and distributors of these laser-illuminated projectors.
- The Christie Laser Projection System Installation Checklist must be fully completed after the installation and sent to [lasercompliance@christiedigital.com](mailto:lasercompliance@christiedigital.com). A copy can remain on-site. This checklist can be found as a separate document in the accessory box with the manual.
- Certain US states have additional laser regulatory requirements. Go to [www.christiedigital.com](http://www.christiedigital.com) for further information.

## Product labels

Learn about the labels that may be used on the product. Labels on your product may be yellow or black and white.

### General hazards

Hazard warnings also apply to accessories once they are installed in a Christie product that is connected to power.

Fire and Shock Hazard	
 	<p>To prevent fire or shock hazards, do not expose this product to rain or moisture.</p> <p>Do not alter the power plug, overload the power outlet, or use it with extension Cords.</p> <p>Do not remove the product enclosure.</p> <p>Only Christie qualified technicians are authorized to service the product.</p>
Electrical Hazard	
	<p>Risk of electric shock.</p> <p>Do not remove the product enclosure.</p> <p>Only Christie qualified technicians are authorized to service the product.</p>



General hazard.



Electric shock hazard. To avoid personal injury, disconnect all power sources before performing maintenance or service.



Electrocution hazard. To avoid personal injury, always disconnect all power sources before performing maintenance or service procedures.



Fire hazard. To avoid personal injury and property damage, follow the instructions provided in this document.



Hot surface hazard. To avoid personal injury, allow the product to cool for the recommended cool down time before performing maintenance or service.



Burn hazard. To avoid personal injury, allow the product to cool for the recommended cool down time before performing maintenance or service.



Bright light hazard. To avoid personal injury, never look directly at the light source.



Moving parts hazard. To avoid personal injury, keep hands clear and loose clothing tied back.



Fan hazard. To avoid personal injury, keep hands clear and loose clothing tied back. Always disconnect all power sources before performing maintenance or service procedures.



Voltage hazard. To avoid personal injury, always disconnect all power sources before performing maintenance or service procedures.



Not for household use.

### Mandatory action



Consult the service manual.



Disconnect all power sources before performing maintenance or service procedures.

### Electrical labels



Indicates the presence of an earth ground.

### Laser labels

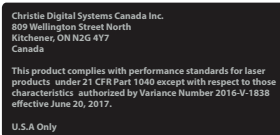

FDA laser variance (US projectors only)



Indicates a light hazard. Do not look directly into the lens. The extreme high brightness can cause permanent eye damage. Class 1 Laser Product-Risk Group 3 according to Class 1 IEC 60825-1:2014 and IEC 62471-5:2015.

### Additional hazard labels



Do not look directly into the lens. The extremely high brightness can cause permanent eye damage.

## Projector overview

The HS Series 2K is a high brightness, professional projector system designed with laser phosphor technology and Digital Light Processing (DLP™) technology from Texas Instruments. Both HD and WUXGA resolutions are available for demands and environments. With its superior image quality and high brightness level, the product can be used for various large venue application ranging from fixed installation, rental stage and LBE (Location Based Entertainment), but not intend to use for domestic purpose.

## Contact your dealer

Record the information about your projector and keep this information with your records to assist with the servicing of your projector. If you encounter a problem with your Christie projector, contact your dealer.

Purchase record	
Dealer:	
Dealer or Christie Sales/Service contact phone number:	
Projector serial number:	
The serial number can be found on the license label located on the display panel	
Purchase date:	
Installation date:	

Ethernet settings	
Default gateway	
Projector IP address	
Subnet mask	

## Key features

Understand the important features of the projector.

- HD 0.95" 1920 × 1080 resolution or WUXGA 0.96" 1920 × 1200 resolution
- High picture quality with superb brightness performance
- Lens suite options for installation flexibility
- Powered lens adjustment with lens memory function
- Projection lens compatibility:
  - Horizontal offset ranges with half image size: up to +/-50%
  - Vertical offset ranges with half image size: up to +/-120% (WUXGA) and +/-140% (HD)  
Measurements comply with industry standards where offset is calculated as a ratio of the number of pixels shifted up or down to half image size.

- 360 degrees projection
- 3D blending and auto warping
- Supports fog filter as an optional accessory
- Full HD 3D technology with frame sequential up to 120 Hz
- Christie Twist™ and Mystique™ allows for easy and quick blending and warping.  
Support for Mystique™ camera based alignment system (sold separately)
- A wide range of connectivity including HDMI, HDBaseT, and 3D inputs
- Integrated HDBaseT solution supports HD video streaming through RJ45
- Wireless desktop display using wireless dongle (optional)
- SNMP traps and email notifications
- 10-bit image processor electronics with modular design
- All video formats can be resized to full screen either horizontally or vertically while maintaining aspect ratio.
- The projector can be operated using any of the following:
  - The built-in keypad, the infrared (IR) remote keypad, a wired remote keypad, or a PC/ device using serial communications (Ethernet or RS232)
  - A web page using Ethernet, or from a PC or device using a wireless USB dongle (optional)

## How the projector works

The HS Series 2K projectors accept a variety of input signals for a wide range of commercial projection applications.

Designed with solid-state illumination light sources and phosphor technology, the red, green and blue color elements are segmented through a phosphor wheel and then modulated by one Digital Micromirror Device (DMD) panel responding to incoming data streams of digitized red, green, and blue color information. As these digital streams flow from the source, light from the responding on pixels of the DMD panel is reflected, converged, and then projected to the screen through projection lenses, where all pixel reflections are superimposed in sharp full-color images.

## List of components

This projector comes with all the items listed below. Check to make sure your package is complete. If anything is missing, contact your dealer.

- AC power cord
- IR remote keypad
- Product Safety Guide

## Product documentation

For installation, setup, and user information, see the product documentation available on the Christie Digital Systems USA Inc. website. Read all instructions before using or servicing this product.

1. Access the documentation from the Christie website:
  - Go to this URL: <http://bit.ly/2JtghsE> or <https://www.christiedigital.com/en-us/business/products/projectors/1-chip-dlp/hs-series>
  - Scan the QR code using a QR code reader app on a smartphone or tablet.

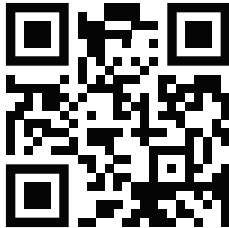

2. On the product page, select the model and switch to the **Downloads** tab.

## Related documentation

Additional information on the projector is available in the following documents.

- *HS Series 2K Installation and Setup Guide (P/N: 020-001464-XX)*
- *HS Series 2K Product Safety Guide (P/N: 020-001465-XX)*
- *HS Series 2K User Manual (P/N: 020-001466-XX)*
- *HS Series 2K Specification Guide (P/N: 020-001467-XX)*
- *HS Series 2K Service Manual (P/N: 020-001468-XX)*
- *HS Series 2K Lens Throw Ratios Technical Reference (P/N: 020-102953-XX)*
- *HS Series 2K Serial Commands Technical Reference (P/N: 020-102783-XX)*
- *Twist User Guide (P/N: 020-101380-XX)*
- *Mystique Operate Instruction Sheet (P/N: 020-102382-XX)*



## Site requirements

To safely install and operate the projector, the installation location must have restricted access for authorized personnel only and meet these minimum requirements.

### Physical operating environment

Provides specifications for the operating environment.

- Ambient temperature (operating): 0°C to 40°C (32°F to 104°F ) up to 2500 ft
- Humidity (non-condensing): 10% to 85% RH
- Operating altitude: 10,000 ft maximum at 0°C to 30°C ambient temperature

### Power connection

The projector uses an AC power system that allows the projector to operate at full brightness with a power supply of 100 to 240 VAC, depending on the models and regions. Operating the device outside of the voltage range may cause unsatisfactory operation or damage to the projector. Christie recommends a 20 A rated wall breaker for the installation. To ensure safety operation, only use the AC power cord provided with the product or recommended by Christie.

Model name	Power requirements
D13WU2-HS/D13HD2-HS	120 - 240 VAC, 50/60 Hz, 12 A 200 - 240 VAC, 50/60 Hz, 7 A (rated for China, India, Taiwan, and Korea) 100 VAC, 50/60 Hz, 13 A, 1200 W (rated for Japan)
D16WU-HS/D16HD-HS	120 - 240 VAC, 50/60 Hz, 12 A 200 - 240 VAC, 50/60 Hz, 7 A (rated for China, India, Taiwan, and Korea) 200 VAC, 50/60 Hz, 7 A, 1250 W (rated for Japan)
D20WU-HS/D20HD-HS	200 - 240 VAC, 50/60 Hz, 9 A

# Projector components

Identify the main components of the projector.

## Front view

Identify the main components on the front of the projector.

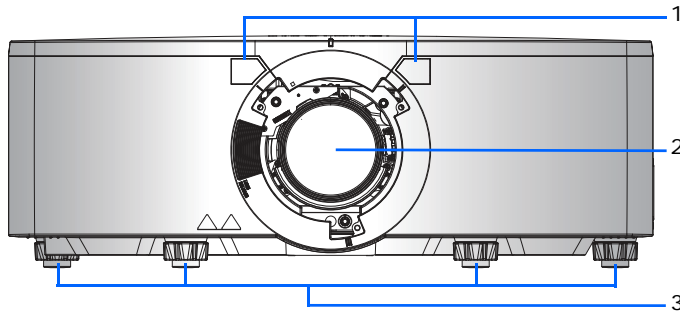

ID	Part name	Description
1	Front IR sensors	Receives signals from the IR remote keypad. Keep the signal path to the sensor unobstructed for uninterrupted communication with the projector.
2	Projection lens	Allows automated lens control and adjustment: vertical and horizontal offsets, zoom, and focus.
3	Adjustable feet	Raises or lowers the feet to level the projector.

## Rear view

Identify the main components on the rear of the projector.

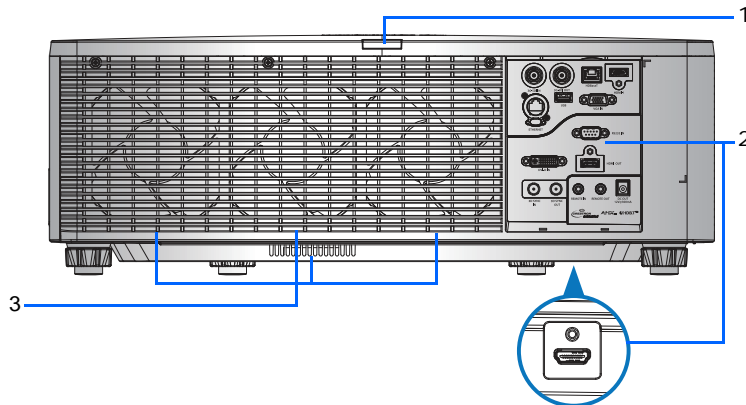

ID	Part name	Description
1	Rear IR sensor	Receives signals from the IR remote keypad. Keep the signal path unobstructed for uninterrupted communication with the projector.
2	Input/Output (I/O) panel	Connects the projector to external devices.

ID	Part name	Description
3	Cooling air vents (exhaust)	Provides cooling to the projector. Keep these vents unobstructed to prevent the projector from overheating.

## Left view

Identify the main components on the left side of the projector.

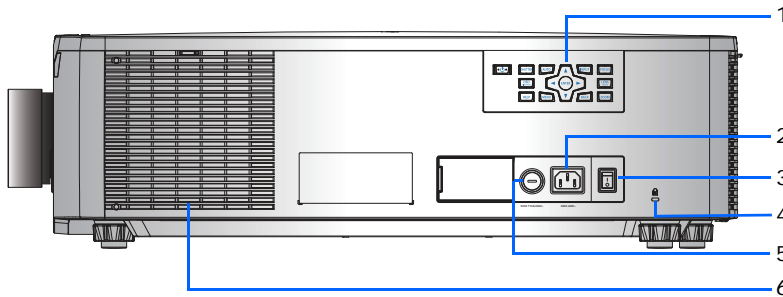

ID	Part name	Description
1	Built-in keypad	Controls the projector.
2	AC input	Connects to the supplied power adapter.
3	Power button	Powers the projector on or off.
4	Kensington lock	Secures the projector to counter tops, tables, and so on.
5	Fuse	FUSE T15 A/250 VAC
6	Cooling air vents (intake)	Provides cooling to the projector. Keep these vents unobstructed to prevent the projector from overheating.

## Right view

Identify the main component on the right side of the projector.

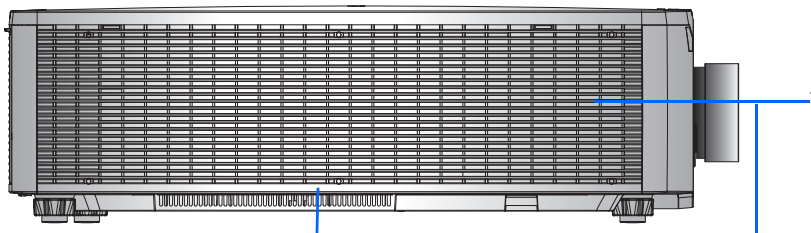

ID	Part name	Description
1	Cooling air vents (intake)	Provides cooling to the projector. Keep these vents unobstructed to prevent the projector from overheating.

## Built-in keypad

The built-in keypad controls the projector.

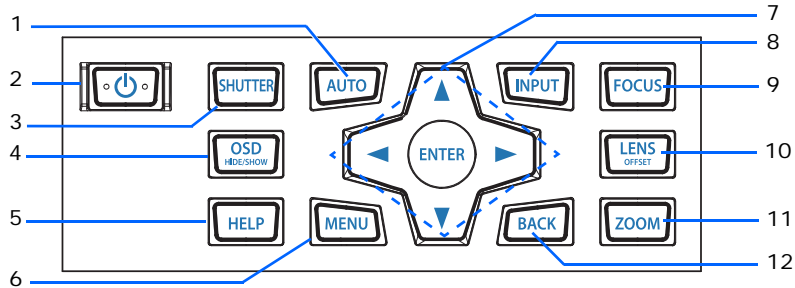

ID	Button	Description
1	AUTO	Automatically optimizes an image.
2	POWER	Turns the projector on or off.
3	SHUTTER	Displays or blanks the video image.
4	OSD HIDE/SHOW	Hides or shows the on-screen display (OSD) menus.
5	HELP	Displays the instructions for source connection.
6	MENU	Displays the menus.
7	Arrow Keys	Adjusts a setting up or down, or navigate within a menu.
8	INPUT	Selects an input for the main or picture in picture/picture by picture (PIP/PBP) image.
9	FOCUS	Adjusts the focus.
10	LENS OFFSET	Adjusts the lens vertical or horizontal offset setting.
11	ZOOM	Adjusts the zoom.
12	BACK	Returns to the previous level or exits the menus if at top level.

# Input/output (I/O) panel

Identify the components of the I/O panel.

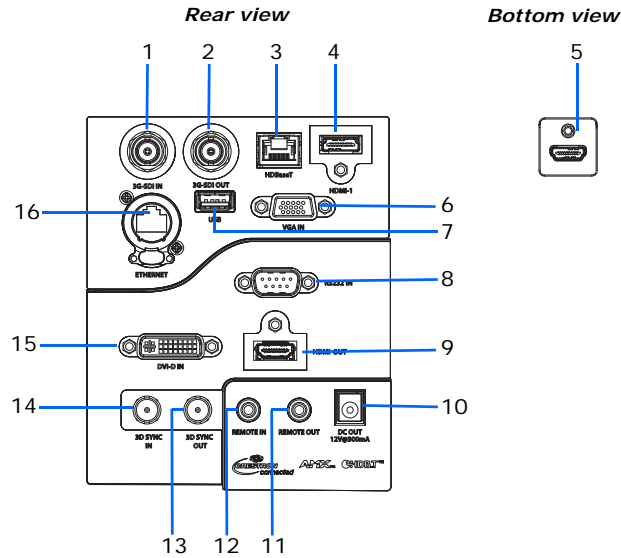

ID	Connector name	ID	Connector name
1	3G-SDI IN	9	HDMI OUT
2	3G-SDI OUT	10	DC OUT
3	HDBaseT	11	REMOTE OUT
4	HDMI-1	12	REMOTE IN
5	HDMI-2	13	3D SYNC OUT
6	VGA IN	14	3D SYNC IN
7	USB (5 V/500 mA)	15	DVI-D IN
8	RS232 IN	16	ETHERNET (10/100 Mbps)

## IR remote keypad

The IR remote keypad communicates with the projector by way of wireless communications.

Use a cable length of 20 m or less. If the length of cable exceeds 20 m, the IR remote keypad may not work correctly.

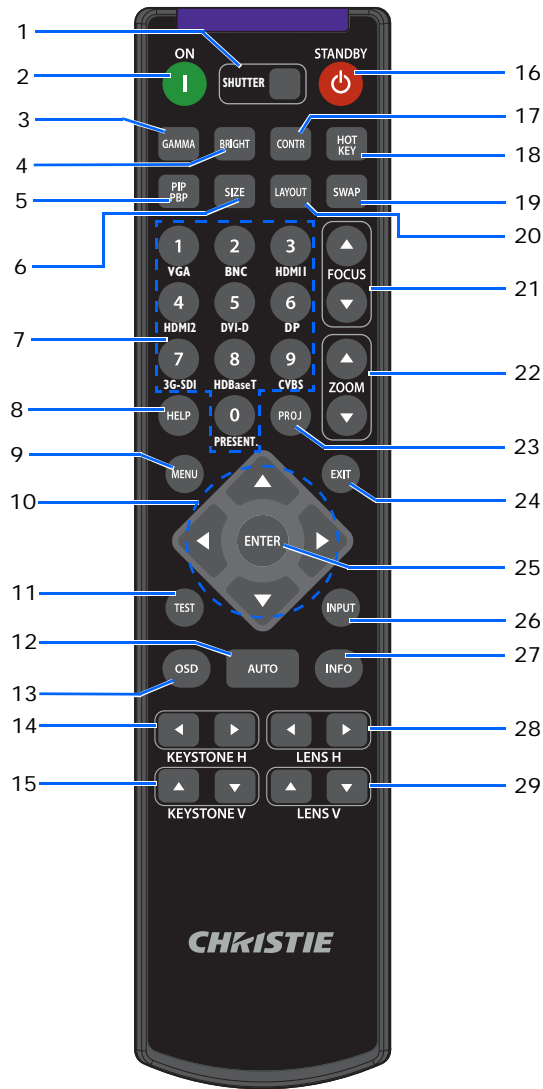

ID	Button	Description
1	SHUTTER	Displays or blanks the video image.
2	ON	Turns the projector on.
3	GAMMA	Adjusts the mid-range levels.
4	BRIGHT	Adjusts the amount of light in the image.

ID	Button	Description
5	PIP PBP	Turns picture-in-picture/picture-by-picture (PIP/PBP) on or off.
6	SIZE	Adjusts the PIP/PBP size.
7	Number Keys	Enter a number, such as a channel, value, and so on. The on-screen display (OSD) indicates if a function is not supported.
8	HELP	Displays the instructions for source connection.
9	MENU	Displays the menus.
10	Arrow Keys	Adjusts a setting up or down to navigate within a menu.
11	TEST	Displays a test pattern.
12	AUTO	Automatically optimizes an image.
13	OSD	Hides or shows OSD menus.
14	KEYSTONE H	Adjusts the horizontal keystone.
15	KEYSTONE V	Adjusts the vertical keystone.
16	STANDBY	Turns the projector off.
17	CONTR	Adjusts the difference between dark and light.
18	HOT KEY	Selects your preset key quickly.
19	SWAP	Swaps the main and PIP/PBP images.
20	LAYOUT	Adjusts the PIP/PBP layout.
21	FOCUS	Adjusts the focus to improve image clarity as required.
22	ZOOM	Adjusts the zoom to achieve a required image size.
23	PROJ	Changes the IR remote keypad ID. <ul style="list-style-type: none"> <li>• To assign an ID, press <b>PROJ</b> + &lt;1 to 9&gt;.</li> <li>• To return to the universal IR remote ID, press <b>PROJ</b> + <b>0</b>.</li> </ul>
24	EXIT	Returns to the previous level or exits menus if at the top level.
25	ENTER	Selects a highlighted menu item, or changes or accepts a value.
26	INPUT	Selects an input for the main or PIP/PBP image.
27	INFO	Displays the projector information.
28	LENS H	Adjusts the position of the image horizontally.
29	LENS V	Adjusts the position of the image vertically.

## Turning on the projector

The projector cables must be securely connected before turning the power on.



**Warning!** Failure to comply with the following could result in death or serious injury.

- Do not look into the projector lens when the laser is on. The bright light may result in permanent eye damage.

1. Plug the projector in to AC power.

The Power button on the built in keypad is illuminated when the power cables are connected.

2. Ensure the lens has been installed in the projector by a Christie qualified service technician.



**Warning!** Failure to comply with the following could result in death or serious injury.

- Installing or replacing a lens must be done by a Christie qualified service technician to avoid exposure to dangerous emission levels.

3. Ensure that no one or no objects are in the beam path before turning on the projector.

4. To turn on the projector, on the IR remote keypad on the built-in keypad press .

The status LED is green with a long blink.

5. To select an input source and turn it on, on the IR remote keypad select **INPUT**.

Available input sources are VGA, HDMI1, HDMI2, DVI, 3G-SDI, and HDBaseT.

The projector detects the source you selected and displays the image.

6. If using the projector for the first time, select a preferred language from the Main Menu after the startup screen is displayed.

## Turning off the projector

Power off the projector in preparation for inspection or maintenance.

1. To turn the projector off, on the IR remote keypad or built-in keypad press .

A warning message appears on the displayed image.

2. To confirm your selection, press  again.

If you do not press  again, the warning message disappears after three seconds and the projector remains on.



## LED status indicator

LED status indicator helps identify the projector state. LEDs are defined below.

### Status LED

Identify the LED state colors and meaning.

LED status	Projector state
Off	AC power is off (without AC plugged in).
Green (flashing)	Projector is starting up.
Green (solid)	System is operating normally.
Blue (flashing)	Projector is cooling down.
Blue (solid)	Projector is in standby mode.
Yellow (flashing)	A problem exists with the projector that does not cause it to shut down. Examples of warnings include: filter needs changing, one of the pumps is damaged, or a fan is operating at full speed due to over temperature of laser diode (LD) driver.
Yellow (solid)	The end user is turning off the projector while it is in a warning state.
Red (flashing)	An error with the projector exists causing it to shut down. Examples of errors include: fan failure, over temperature, wrongly installed filter, or color wheel (CW) failure.
Red (solid)	The user is turning off the projector while it is in an error state.
White (flashing)	Projector is in a flash (LAN) update state.

### Shutter LED

Identify the shutter LED state colors and meaning.

LED Status	Projector State
Off	Projector is on and an image is displayed. Shutter is open.
Magenta (solid)	Projector is on and the image is blank. Shutter is closed.

# Adjusting the size and position

Adjust the projector's size and position. Christie recommends warming the lens before completing these procedures as focus may change as the lens warms.

## Setting the image size preset

Set the image size preset to display the image in its native resolution or to resize by maximizing the height, width, both height and width, or to the maximum size while keeping the original aspect ratio.

1. Select **Menu > Size & Position > Size Presets**.
2. Select the appropriate size preset:
  - **Auto**—Display with the detected size.
  - **Native**—Display in its native resolution.
  - **4:3**—Retain 4:3 aspect ratio.
  - **Letterbox**—Make the active content enlarge to the full screen.
  - **Full Size**—Fill the screen, regardless of the source.
  - **Full Width**—Fill display width and keep aspect ratio.
  - **Full Height**—Fill display height and keep aspect ratio.
  - **Custom**—Stretch the display horizontally and vertically without cutting the image display.
  - **3D Mode**—Display 3D content. All other items are grayed out, if 3D Mode is selected.
3. To confirm the selection, press **ENTER**.

## Adjusting pixel phase

Adjust the pixel phase when the image shows shimmer or noise. Pixel phase can adjust the phase of the pixel-sampling clock relative to the incoming signal. This feature is for analog RGB signals only.

1. Select **Menu > Size & Position > Pixel Phase**.
2. Adjust the slider by arrow keys or press **ENTER** to input the values of pixel phase.
3. After inputting the value, press **ENTER** to apply.

## Setting the position of display image

Move the image vertically or horizontally to correct the position of the display image.

1. Select **Menu > Size & Position > Horz Position** or **Vert Position**.
2. Adjust the slider by arrow keys or press **ENTER** to input the values of moving pixels.
3. After inputting the value, press **ENTER** to apply.

## Setting the digital size of display image

These functions are similar technologies as in-camera image processing. Use Digital Horz Zoom or Digital Vert Zoom to enlarge or to compress the display image horizontally or vertically.

1. Select **Menu > Size & Position > Digital Horz Zoom** or **Digital Vert Zoom**.
2. Adjust the slider by arrow keys or press **ENTER** to input the value you selected.
3. After inputting the value, press **ENTER** to apply.

## Setting the digital position of display image

Change the position of the projector's display image horizontally or vertically.



Digital Horz Shift is only available after adjusting the Digital Horz Zoom, and Digital Vert Shift is only available after adjusting the Digital Vert Zoom.

1. Select **Menu > Size & Position > Digital Horz Shift** or **Digital Vert Shift**.
2. Adjust the slider by arrow keys or press **ENTER** to input the value you selected.
3. After inputting the value, press **ENTER** to apply.

## Geometry correction

Modify the geometry of the display image directly on the projector.

Connecting to Christie Twist and Mystique grays out the geometry correction settings on the projector. Uploading warp and blend from Twist and Mystique overwrites the currently applied geometry correction settings. See [Configuring warp and blend](#) on page 31 for more details.

## Saving geometry correction

Save the warp and blend settings to the projector memory. The blend memory saves the edge blend settings, while the warp memory saves the settings of Keystone, Pincushion, 4-Corner, Manual Warp Filter, and image warp.

1. Select **Menu > Size & Position > Geometry Correction > Warp Memory > Save Warp or Blend Memory > Save Blend**.
2. To save the geometry setting, select a record.  
One projector can save up to four warps and four blends.
3. To confirm the selection, press **ENTER**.

## Applying geometry correction

Apply the previously saved geometry setting to the projector.

1. Before applying the previous geometry setting, save the geometry setting to the projector.  
See [Saving geometry correction](#) on page 28 for further information.
2. Select **Menu > Size & Position > Geometry Correction > Warp Memory > Apply Warp or Blend Memory > Apply Blend**.
3. To apply the specific geometry setting, select the required record.
4. To confirm the selection, press **ENTER**.
5. To erase the applied geometry setting, select **Off**.

## Adjusting horizontal keystone

Use horizontal keystone to correct a keystone image shape in which the left and right borders of the image are unequal in length, and the top and bottom are slanted to one of the sides.

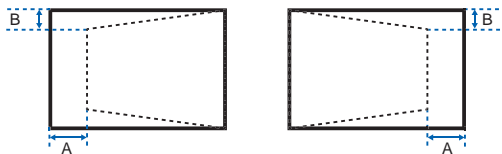

1. Select **Menu > Size & Position > Geometry Correction > Keystone > Horz Keystone**.
2. To adjust the horizontal keystone, adjust the slider by arrow keys or press **ENTER** to input the value you selected.
3. After inputting the value, press **ENTER** to apply.

## Adjusting the vertical keystone

Use vertical keystone to correct a keystone image shape in which the top and bottom borders of the image are unequal in length, and both sides of the image are inclined toward the top or bottom edge.

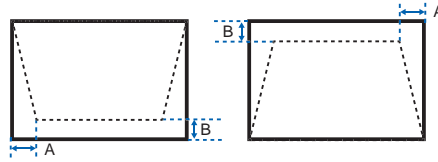

1. Select **Menu > Size & Position > Geometry Correction > Keystone > Vert Keystone**.
2. To adjust the vertical keystone, adjust the slider by arrow keys or press **ENTER** to input the value you selected.
3. After inputting the value, press **ENTER** to apply.

## Adjusting horizontal pincushion

Use horizontal pincushion to correct a pinched image shape in which the horizontal straight lines are curved inwards or horizontal straight lines are curved outwards from the center.

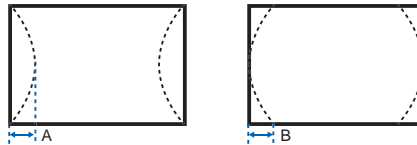

1. Select **Menu > Size & Position > Geometry Correction > Pincushion > Horz Pincushion**.
2. To adjust the horizontal pincushion, adjust the slider by arrow keys or press **ENTER** to input the value you selected.
3. After inputting the value, press **ENTER** to apply.

## Adjusting vertical pincushion

Use vertical pincushion to correct a pinched image shape in which the vertical straight lines are curved inwards or vertical straight lines are curved outwards from the center.

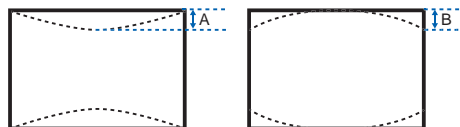

1. Select **Menu > Size & Position > Geometry Correction > Pincushion > Vert Pincushion**.
2. To adjust the vertical pincushion, adjust the slider by arrow keys or press **ENTER** to input the value you selected.
3. After inputting the value, press **ENTER** to apply.

## Adjusting 4-corner

Use 4-corner to correct the four corners of the projector's display image.

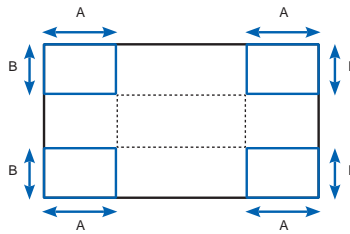

1. Select **Menu > Size & Position > Geometry Correction > 4-Corner**.
2. Select the corner and the direction to adjust.
3. To move the corner, adjust the slider by arrow keys or press **ENTER** to input the value.
4. After inputting the value, press **ENTER** to apply.
5. To adjust the other corner or direction, repeat step 2 to 4.

## Enabling auto warp filter

Improve the sharpness of the image and reduce the ghosting automatically after geometry correction, such as keystone, pincushion, 4-corner, and warping.

1. Select **Menu > Size & Position > Geometry Correction > Auto Warp Filter**.
2. To enable the setting, press **ENTER**.

## Adjusting warp filter

Improve the sharpness of the image after geometry correction, such as keystone, pincushion, 4-corner, and warping. Adjust the warp filter manually to reduce the ghosting.

1. Select **Menu > Size & Position > Geometry Correction > Manual Warp Filter**.
2. To reduce the ghosting in different direction, select **Horz Filter** or **Vert Filter**.
3. Adjust the slider by arrow keys or press **ENTER** to input the value.
4. After inputting the value, press **ENTER** to apply.

## Resetting geometry correction setting

Reset all geometry correction parameters back to default, including warp and blend settings.

1. Select **Menu > Size & Position > Geometry Correction > Reset to Default**.
2. Press **ENTER**.

## Configuring warp and blend

By blending multiple images, you can combine several projectors to create a larger and seamless image. When the projection screen is not perfectly flat or rotated at an angle, warp the image to fit on the irregular surface.

### Warping an image

Christie Twist offer various manual warping options to adjust the image shape with minimal performance impact. Refer to the Christie website ([www.christiedigital.com](http://www.christiedigital.com)) for product information and documentation.

1. Connect the projector and computer to the same network and subnet.
2. To add a projector to a computer, from the Twist menu, click **Home > Add**.
  - To manually connect the projector with Twist, use port 3003.
  - Connecting to Twist grays out the Geometry Correction settings on the projector.
3. Select a record number to save the warp.

You can save up to four warp settings.
4. In Twist, configure warp settings.

Use the test patterns in Twist to help with image shaping.

For more information about creating warp files in Twist, refer to *Twist User Guide (P/N: 020-101380-XX)*.
5. To send the warp settings to the projector, on the canvas, right-click a projector window and select **Send Warp**.
6. To save the warp settings on the projector, click **File > Save** or **Save As**.

When removing the projector from Twist, or closing the program, the projector automatically saves the currently applied warp settings to its warp memory.
7. To change the name when saving warps on the projector, or update the memory location of the warp, click **Properties**.

The changed name shows on both Twist and the projector.



Christie Twist can be upgraded to Twist Premium and Twist Pro that provides more advanced warping features. Refer to the Christie website ([www.christiedigital.com](http://www.christiedigital.com)) for product information and documentation.

## Downloading a warp from the projector memory

Use Twist to download the warp file saved on the projector memory.

1. Before downloading the previous warp file, save the warp setting to the projector memory.
2. On the canvas, click a projector window.
3. Click **File > Warp**.
4. In the Download from Memory Location list, select the required record.

5. To download the selected warp setting, click **OK**.
6. To apply the warp setting to the projector, on the canvas, right-click a projector window and select **Send Warp**.

## Enabling basic image blending

Configure blends directly on the projector to increase or decrease the borders of an individual image, so it blends with a neighboring image to create a single, seamless image.

You can set blends on a projector when not using Christie Twist and Mystique. Connecting to Twist and Mystique grays out the blend settings on the projector. Applying blends from Twist and Mystique overwrites the blends directly set on the projectors.

1. Select **Menu > Size & Position > Geometry Correction > Blend Area**.
2. Choose a side to blend in with the other projectors.
3. To set up the starting position, select **Start Pixel**.
4. Adjust the slider by arrow keys or press **ENTER** to input the starting position.
5. After inputting the starting position, press **ENTER**.
6. To set up the size of blend area, select **Pixel Height**.
7. Adjust the slider by arrow keys or press **ENTER** to input the width of blend area.
8. After inputting the size of blend area, press **ENTER**.
9. To set the gamma value of the blend area, select **Blend Gamma**.
10. After selecting a gamma value, press **ENTER**.
11. To apply the settings, select **Enable**.
12. Press **ENTER**.
13. To save the blend setting, select **Menu > Size & Position > Geometry Correction > Blend Memory > Save Blend**.
14. To set up the other side of blend area, repeat step 2 to 13.

## Blending multiple images

Use Christie Twist to manually configure edge blends and apply them to the projectors.

Christie Twist Premium and Twist Pro offer advanced blending options. Refer to the Christie website ([www.christiedigital.com](http://www.christiedigital.com)) for product information and documentation.

1. Connect the projector and computer to the same network and subnet.
2. To add a projector to a computer, from the Twist menu, click **Home > Add**.
  - To manually connect the projector with Twist, use port 3003.
  - Connecting to Twist grays out the Geometry Correction settings on the projector.
3. Select a record number to save the blend setting.

You can save up to four blend settings.



4. In Twist, configure edge blend settings.  
Use the test patterns in Twist to assist in adjusting the blend area.  
For more information about creating blend files in Twist, refer to *Twist User Guide (P/N: 020-101380-XX)*.
5. To send the blend settings to the projector, on the canvas, right-click a projector window and select **Send Blend**.
6. Repeat step 2 to 5 for the remaining projectors.  
For multiple projectors, use Twist to identify the projectors.
7. To save the warp file on the projector, click **File > Save** or **Save As**.  
When removing the projector from Twist, or closing the program, the projector automatically saves the currently applied blend settings to its blend memory.
8. To change the name when saving blends on the projector, or update the memory location of the blend, click **Properties**.  
The changed name shows on both Twist and the projector.

## Downloading a blend from the projector memory

Use Twist to download the blend file saved on the projector memory.

1. Before downloading the previous blend file, save the blend setting to the projector memory.
2. On the canvas, click a projector window.
3. Click **File > Blend/Mask/B.U**.
4. In the **Download Blend** dialog, select the required record.
5. To download the selected blend setting, click **OK**.
6. To apply the blend setting to the projector, on the canvas, right-click a projector window and select **Send Blend**.

## Performing auto warp and blend

Use Mystique (sold separately) to perform automatic warp, blend, and more advanced geometry settings. Mystique is an automated camera-based alignment and recalibration solution that lets you quickly stage, install, align, calibrate, and maintain multi-projection systems.

Refer to the Christie website ([www.christiedigital.com](http://www.christiedigital.com)) for product information and documentation.

# Adjusting the image settings

Learn how to adjust the projector image.

## Adjusting the brightness

Adjust the intensity of the image.

1. Select **Menu** > **Image Settings** > **Brightness**.
2. Adjust the slider by arrow keys or press **ENTER** to input the value.
3. After inputting the value, press **ENTER** to apply.

## Adjusting the contrast

Adjust the degree of difference between the lightest and darkest parts of the image and changes the amount of black and white in the image.

1. Select **Menu** > **Image Settings** > **Contrast**.
2. Adjust the slider by arrow keys or press **ENTER** to input the value.
3. After inputting the value, press **ENTER** to apply.

## Adjusting the color space

Determine how the color components are decoded for accurate color in the display.

1. Select **Menu** > **Image Settings** > **Color Space**.
2. If projector does not detect the correct input signal while **Auto** is enabled, unable **Auto** by pressing **ENTER** to select color space manually.
3. To match up with the input signal, select appropriate color space:
  - Auto
  - RGB

- RGB Full
  - RGB Limited
  - YUV
    - REC709
    - REC601
4. To confirm the selection, press **ENTER**.

## Adjusting the image sharpness

Adjust the edge clarity of the image.

1. Select **Menu > Image Settings > Detail**.
2. Select the sharpness:
  - Maximum
  - High
  - Normal
  - Low
  - Minimum
3. To confirm the selection, press **ENTER**.

## Setting up 3D display

Use the functions in 3D Display menu to make the timing adjustment and environment necessary for displaying 3D images.

### Setting 3D format

Set up the 3D format according to the 3D input signal.

1. Select **Menu > Image Settings > 3D Display > 3D Enable**.
2. Select the appropriate 3D format:
  - Auto
  - Frame Packing
  - Side by Side
  - Top and Bottom
  - Frame Sequential
  - Off
3. To confirm the selection, press **ENTER**.

## Inverting 3D signal

3D images consist of a series of images (frames) that alternate quickly between two slightly different view points, corresponding to our left and right eyes. When these frames are displayed fast enough and viewed with 3D glasses synchronized to the left/right (L/R) changes, the resulting image appears with the same depth and perspective that is sensed in the real world.

If the projector generates the sync internally and content is displayed without 3D sync in the cable connected to the projector, there is a 50% chance that the content is displayed with the left/right eyes swapped. This function is used for swapping the sequence of the image to make the resulting image appear normally.

1. Select **Menu > Image Settings > 3D Display > 3D Invert**.
2. To swap, press **ENTER**.

## Setting the 3D sync output signal

This function is used for controlling and processing the 3D sync output signal.

1. Select **Menu > Image Settings > 3D Display > 3D Sync Out**.
2. Select the appropriate 3D sync out setting.
  - **To Emitter**—If the 3D sync out port is connected to an emitter, select **To Emitter** to transmit 3D signal to emitter and give to 3D glasses.
  - **To Next Projector**—Multiple projectors 3D application only. Select **To Next Projector** when the 3D sync out port is not connected to an emitter.
3. To confirm the selection, press **ENTER**.

## Setting the frame delay

Adjust the frame delay which eliminates the odd colors and cross talk caused by timing difference. Frame delay is the time difference between the first 3D signal being given and the result being executed from current projector.

1. Select **Menu > Image Settings > 3D Display > Frame Delay**.
2. Adjust the slider by arrow keys or press **ENTER** to input the value.
3. After inputting the value, press **ENTER** to apply.

## Setting the left/right (L/R) reference

Set the left/right (L/R) reference for the projector.

1. Select **Menu > Image Settings > 3D Display > L/R Reference**
2. Select the L/R reference:
  - **1st Frame**—Set the 1st frame from the input source as the left reference.
  - **Field GPIO**—Set the Field GPIO of the input source as the left and right reference.
3. To confirm the selection, press **ENTER**.

## Configuring the video settings

Configure the video settings to optimize the image performance, such as applying color to black and white videos, reducing luminance component noise, and so on.

### Adjusting black and white video

Adjust a video image from black and white to fully saturated color. This feature is for video sources only.

1. Select **Menu > Image Settings > Video Options > Color**.
2. Adjust the slider by arrow keys or press **ENTER** to input the value.
3. After inputting the value, press **ENTER** to apply.

### Adjusting the color balance

Adjust the red-green color balance in NTSC video images. NTSC, named after the National Television System Committee, is the analog video color system used in North America and most of the South America countries. This feature is for NTSC video sources only.

1. Select **Menu > Image Settings > Video Options > Tint**.
2. Adjust the slider by arrow keys or press **ENTER** to input the value.
3. After inputting the value, press **ENTER** to apply.

### Adjusting the skin color

Adjust the color tone of human skin in videos.

1. Select **Menu > Image Settings > Video Options > Skin Color**.
2. Select appropriate skin color tone.
3. To confirm the selection, press **ENTER**.

### Reducing the temporal noise

Remove the luminance component noise of the low light videos.

1. Select **Menu > Image Settings > Video Options > Temporal Noise Reduction**.
2. Select appropriate level for temporal noise reduction.
3. To confirm the selection, press **ENTER**.

### Reducing the MPEG noise

MPEG compression causes block noise appears like small blocks in the image, and the image compression algorithms result in mosquito noise around the sharp edges in the image. This function is used to reduce the MPEG noise.

1. Select **Menu > Image Settings > Video Options > MPEG Noise Reduction**.

2. Select appropriate level for MPEG noise reduction.
3. To confirm the selection, press **ENTER**.

## Setting the input levels

If the image is displayed by an analog signal, such as VGA signal, the image may have an odd color on the screen. These functions are used to adjust gain and offset error and correct the color.

### Adjusting the color gain

Set the color gain to correct the color intensity of the image. This function is used when the image is displayed by VGA or component and the color is incorrect.

1. Select **Menu > Image Settings > Input Levels**.
2. Select appropriate color gain:
  - Red Gain
  - Green Gain
  - Blue Gain
3. Adjust the slider by arrow keys or press **ENTER** to input the value.
4. After inputting the value, press **ENTER** to apply.

### Adjusting the color offset

Set the color gain to correct the degree of color difference of the image. This function is used when the image is displayed by VGA signal and the color is incorrect.

1. Select **Menu > Image Settings > Input Levels**.
2. Select appropriate color offset:
  - Red Offset
  - Green Offset
  - Blue Offset
3. Adjust the slider by arrow keys or press **ENTER** to input the value.
4. After inputting the value, press **ENTER** to apply.

### Syncing the input signal

Synchronize the input signal when the projector and the connected hardware device, such as a DVD player, are not syncing properly.

1. Select **Menu > Image Settings > Input Levels > Sync Threshold**.
2. Press **ENTER**.

## Resetting the input levels

Reset all input levels parameters back to default.

1. Select **Menu > Image Settings > Input Levels > Reset to Default**.
2. Press **ENTER**.

## Configuring picture settings

Depending on display content, choose the most suitable picture settings. Different picture settings have different color temperature, brightness, and so on.

1. Select **Menu > Image Settings > Picture Settings**.
2. Select the appropriate picture setting:
  - **Video**—This function is used for theater application. It sets the color temperature to 6000K with 70% of maximum brightness.
  - **Bright**—This function is used for large size or high brightness application. It sets the color temperature to 7500K with 100% brightness.
  - **Enhanced**—This function is used for images with richly saturated and vivid color. It is based on brightness mode.
  - **REC709**—This function is used for high-definition television. It sets the color temperature to 6500K with 80% of the maximum brightness.
  - **DICOM SIM**—This function is used for high contrast content, such as X-ray diagram. It sets the color temperature to 7500K with 65% brightness.
  - **Blending**—This function is used for multiple projector application. It sets the color temperature to 7000K with 85% of maximum brightness.
  - **User**—This is a customized picture setting. See [Saving customized picture setting](#) on page 39 for further details of creating a customized picture setting.
3. Press **ENTER**.

## Saving customized picture setting

Customize the picture setting by adjusting the brightness, contrast, input levels, color temperature, gamma, detail, white peaking, and so on.

1. Adjust the parameters to customize user's picture setting:
  - Color space
  - Color temperature
  - Gamma
  - White peaking
  - Sharpness

- Detail
  - Brightness
  - Contrast
  - HSG adjustment
  - Input level
2. Select **Menu** > **Image Settings** > **Save to User**.
  3. Press **ENTER**.

## Setting the contrast ratio

Use contrast enhancement function to raise the contrast ratio.

1. Select **Menu** > **Image Settings** > **Contrast Enhancement**.
2. Select the appropriate calculation method for contrast ratio:
  - **Off**—Disable the contrast enhancement which show the normal contrast ratio.
  - **Dynamic Black**—Adjust the contrast ratio depending on the contents by minimizing the black levels in the projected image while electronically increasing the gain in the image. The result is enhanced detail and increased contrast ratio of 7500:1 (HD)/6500:1 (WU).
  - **Real Black**—Turn off the laser light while projecting black content.
3. To confirm the selection, press **ENTER**.

## Setting up the Dynamic Black

Depending on the current content, Dynamic Black improves the image contrast and enhances the details by dynamically adjusting the light source and correcting the gain value.

1. Select **Menu** > **Image Settings** > **Dynamic Black**.
2. Select appropriate setting for Dynamic Black:
  - **Speed**—Adjust the speed of the light source correction. The value ranges from 1 to 15. A lower value makes the correction slower and less aggressive while a higher value results in the faster correction.
  - **Strength**—Set the strength of the dynamic contrast adjustment. The value ranges from 0 to 3, the higher the value the stronger the correction.
  - **Level**—Adjust the light source when the brightness level of the current content gets lower than the set value. The value ranges from 50 to 100, indicating 50% to 100% of the constant brightness. The higher the value, the larger the range to adjust the light source.
  - **Real Black**—Enable or disable the Real Black function, which turns off the laser light for black content.
3. To confirm the selection, press **ENTER**.



## Enabling the image freeze

Pause the display screen despite any change in the source device.

1. Select **Menu > Image Settings > Image Freeze**.
2. To pause the screen, check **Image Freeze**.
3. To unfreeze the screen, press any button on the keypad or remote control.
4. Select **Yes**.

## Adjust the color of the image

Calibrate the accuracy of primary colors and the wall color, which can change because of lighting and environmental factors. Lighting and other environmental factors may slightly change how these colors appear on your screen. While the change is negligible in most cases, you may prefer to recover the originally intended color performance before trying to match colors from several projectors.

### Adjusting primary colors

To achieve consistency use a color meter to measure the native primary colors—red, green, blue, and white, as they appear on the screen. Use hue, saturation and gain (HSG) to adjust each color component to essentially calibrate a projector to its surroundings, compensating for factors such as screen type, lamp and/or ambient lighting, and improves color accuracy and consistency in a group of projectors. It ensures a good starting point for further customizing and matching; however, is not critical for all installations.

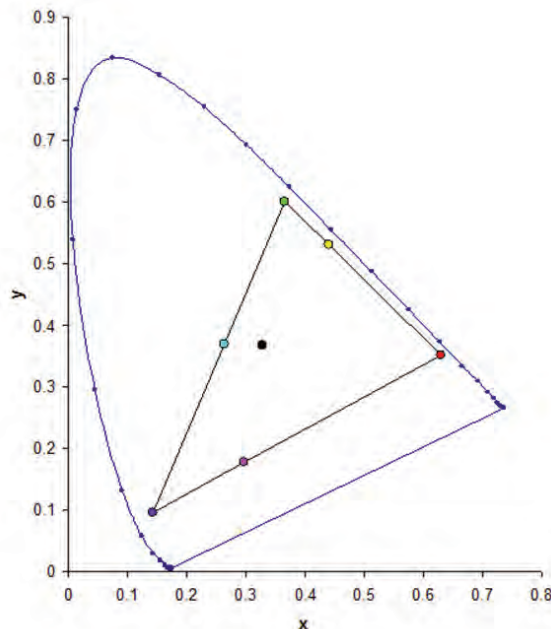

1. Select **Menu > Image Settings > Color Matching > HSG Adjustment**.
2. To enable **HSG Enable**, press **ENTER**.

3. Select one primary color (red, green, blue, cyan, magenta, or yellow).
4. To view a specific color while adjusting, press **ENTER** to enable **Auto Test Pattern**.
5. To edit hue of the primary color, adjust the slider or enter the color values of the primary color component you selected until you are satisfied with the colors.  
Hue values reflect the number of degrees of rotation around the wheel from the original color of the pixel. Increasing the value indicates counterclockwise rotation and decreasing the value indicates clockwise rotation.
6. To confirm the selection, press **ENTER**.
7. To edit saturation of the primary color, adjust the slider or enter the color values of the primary color component you selected until you are satisfied with the colors.  
Saturation values reflect the color shifting away from the primary color or toward white.
8. To confirm the selection, press **ENTER**.
9. To edit gain of the primary, adjust the slider or enter the color values of the primary color component you selected until you are satisfied with the colors.  
Increasing value indicates increasing the lightness, and decreasing the value indicates decreasing it to black.
10. To confirm your selection, press **ENTER**.
11. Repeat steps 3 to 9 for each primary color component, except white.
12. To edit the color of white by three components—red, blue and green—adjust the slider or enter the values until you are satisfied with the white.
13. To confirm your selection, press **ENTER**.
14. To reset the primary colors to their defaults, select **Reset to Default**.
15. To reset back to default setting, press **ENTER**.
16. You can also use the color enhancement settings preset in the projector.
  - a. To disable the HSG adjustment, uncheck **HSG Enable**.
  - b. To enrich the color saturation, select **Color Enhance > CE1**.
  - c. To increase the image brightness, select **CE2**.

## Setting the wall color

Set the wall color so the projector can enhance the color performance customized for the specific wall.

1. Select **Menu > Image Settings > Color Matching > Wall Color**.
2. Select the preferred setting:
  - White
  - Gray 130
  - Light Yellow
3. Press **ENTER**.

## Adjusting the color value based on gamma setting

Adjust the color values to give a more detailed displayed image.

1. Select **Menu > Image Settings > Advanced Image Settings > Gamma**.
2. Select the appropriate option:
  - Video
  - Film
  - Bright
  - CRT
  - DICOM
3. Press **ENTER**.

## Adjusting the white peaking

Use white peaking to adjust the color of white. The maximum value of white peaking, 100, can increase the brightness of white to near 100%.

1. Select **Menu > Image Settings > Advanced Image Settings > White Peaking**.
2. Adjust the slider by arrow keys or press **ENTER** to input the value.
3. Press **ENTER**.

## Adjusting the color temperature

Adjust the color temperature as expressed in degrees Kelvin.

1. Select **Menu > Image Settings > Advanced Image Settings > Color Temperature**.
2. Select appropriate color temperature:
  - **Warmest**—Set the color temperature to 5500K.
  - **Warm**—Set the color temperature to 6500K.
  - **Cool**—Set the color temperature to 7500K.
3. Press **ENTER**.

## Adjusting the color wheel speed

Adjust the color wheel speed, which affects the projector's noise level, lifetime, and eliminates the rainbow phenomenon.

1. Select **Menu > Image Settings > Advanced Image Settings > Color Wheel Speed**.

2. Select appropriate color temperature:
  - **2X**—Increase the projector's lifetime and reduce the noise level.
  - **3X**—Eliminate the rainbow phenomenon.
3. Press **ENTER**.

## Setting the Real Black threshold

Improve the contrast ratio by turning off the laser light when projecting black content. Set the Real Black threshold to fit different installation requirements.

1. Select **Menu > Image Settings > Advanced Image Settings > Threshold for RealBlack**.
2. Select appropriate real black setting:
  - **Lights Out Timer (x0.5)**—Set a timer for the laser light to turn off after detecting black content.
  - **Lights Out Signal Level**—Set a black level value as the threshold for the Real Black function. The value can be selected from 0 to 5, with 0 being the darkest black and 5 being the brightest.
3. To confirm the selection, press **ENTER**.

## Configuring the HDMI setting

Enable or disable the Extended Display Identification Data (EDID) for HDMI 2.0 to play videos from hardware devices, such as DVD players.

The most commonly used HDMI versions are HDMI 1.4 and 2.0, with differences in bandwidth. HDMI 2.0 plays 4K video without compromise, at 50 and 60 frames per second. In HDMI 1.4, the rate of 4K is limited to 30 frames per second. The HS Series 2K projector is compatible with both HDMI 1.4 and HDMI 2.0. When the projector is connected to a hardware device supporting HDMI 1.4 only, disable the EDID for HDMI 2.0 to play the videos properly.

1. Select **Menu > Image Settings > Advanced Image Settings > 4K Compatible**.
2. To enable the EDID for HDMI 2.0, check **4K Compatible**.
3. To confirm the setting, press **ENTER**.

# Configuring system settings

Learn how to configure the system settings.

## Changing the language

Choose the language you want displayed on projector display panel and on-screen display.

1. Select **Menu > Configuration > Language**.  
You can also select **Menu > Language**.
2. Select the appropriate language.
3. Press **ENTER**.

## Adjusting lens settings

Adjust various lens settings including the lens type, zoom, focus, lens position, memorizing lens position and locking the lens motors.

## Viewing the lens type

Set up the correct lens type to have the correct offset range.

1. Select **Menu > Configuration > Lens Settings**.  
The **Lens Type** on the top of the menu displays the lens information.
  - Undefined lens
  - Standard lens TR 1.5-2.0: 1
  - Optional lens TR 1.2-1.5: 1
  - Optional lens TR 2.0-4.0: 1
  - Optional lens TR 4.0-7.2: 1

## Aligning the image with zoom and focus

Ensure that the image reflected from the digital micromirror device (DMD) is parallel and centered with the lens and screen.

1. Display an image or test pattern that can be used to analyze image focus and geometry.
2. Press **ZOOM** on keypad or remote control.  
You can also select **Menu > Configuration > Lens Settings > Zoom**.
3. Use the up and down arrow keys to zoom in or out of the image.
4. To exit the menu, press **EXIT**.
5. Press **FOCUS** on keypad or remote control.  
You can also select **Menu > Configuration > Lens Settings > Focus**.
6. Use the up and down arrow keys to adjust the focus of the image.
7. To exit the menu, press **EXIT**.
8. To refine your adjusts, repeat steps 2 to 7.

## Adjusting lens position

Shift the lens to the specific position.

1. Display an image or test pattern that can be used to analyze image location.
2. Press **LENS** on keypad or **LENS H/LENS V** on remote control.  
You can also select **Menu > Configuration > Lens Settings > Lens Shift**.
3. Use the arrow keys to adjust the lens position.
4. To exit the menu, press **EXIT**.

## Saving lens setting

Save the lens position, zoom and focus. One projector can save maximum up to five lens settings.

1. Select **Menu > Configuration > Lens Settings > Lens Memory > Save Current Settings**.
2. To save the lens setting, select an empty record.
3. To confirm the selection, press **ENTER**.

## Applying the previous lens setting

Apply the previously saved lens setting to the projector.

1. Before applying the previous lens setting, you need to save the lens setting.  
See [Saving lens setting](#) on page 46 for further details.
2. Select **Menu > Configuration > Lens Settings > Lens Memory > Apply Position**.
3. To apply specific lens setting, select the required record.

4. To confirm the selection, press **ENTER**.

## Locking the lens motor

Prevent all lens motors from moving. It disables the zoom, focus, and offset settings, locking out any changes and overriding all other lens features. This feature prevents accidental lens position changes in multiple projectors installations.

1. Select **Menu > Configuration > Lens Settings > Lock all Lens Motors**.
2. To enable locking of all lens motors, select **Locked**.
3. To unlock all lens motors, select **Allow**.
4. To confirm the selection, press **ENTER**.

## Resetting the lens to home position

Set the lens offset back to the home position.

1. Select **Menu > Configuration > Lens Settings > Lens Calibration**.  
You can also press **LENS** on keypad or **LENS H/LENS V** on remote control.
2. Press **ENTER**.
3. To start the lens calibration, select **OK**.

## Selecting screen image orientation

Specify the orientation to use for the image. The projector supports front projection, rear projection, front projection inverted, or rear projection inverted.

1. To invert the projection image, select **Menu > Configuration > Ceiling Mount**.
2. Select appropriate ceiling mount settings:
  - **Auto**—Detect the orientation automatically.
  - **Off**—Disable the ceiling mount setting.
  - **On**—Enable the ceiling mount setting.
3. To confirm the image orientation, press **ENTER**.
4. To do a rear projection, select **Menu > Configuration > Rear Projection**.
5. To swap, press **ENTER**.

## Adjusting on-screen display menus

Adjust various on-screen display (OSD) settings including the position, OSD transparency and timing for OSD to disappear.

### Determining the on-screen display position

Adjust the location of the on-screen display (OSD) menus.

1. Select **MENU > Configuration > Menu Preferences > Menu Horz Offset** or **Menu Vert Offset**.
2. To determine the location on the screen where you want OSD to appear, adjust the slider by arrow keys or press **ENTER** to input the value.
3. After inputting the value, press **ENTER** to apply.

### Setting the transparency of the on-screen display position

Change the on-screen display (OSD) menu background to be transparent. As the value increases, more of the image behind the menu is visible.

1. Select **MENU > Configuration > Menu Preferences > Menu Transparency**.
2. Adjust the slider by arrow keys or press **ENTER** to input the value.
3. After inputting the value, press **ENTER** to apply.

### Setting time out for on-screen display

Adjust the time for on-screen display to disappear.

1. Select **Menu > Configuration > Menu Preferences > Menu Time Out**.
2. Select the appropriate time:
  - Off
  - 1 Min
  - 3 Min
3. Press **ENTER**.

## Showing Messages

Enable or disable the on screen message dialogs. For example, input source, IP Address, Slot information, Gamma information, and so on.

1. Select **Menu > Configuration > Menu Preferences > Show Messages**.
2. To swap, press **ENTER**.



## Changing the splash screen

Select splash screen which is the screen with no source is displayed.

1. Select **Menu > Configuration > Menu Preferences > Splash Screen Setup**.
2. Select the appropriate splash screen:
  - Factory Logo
  - Blue
  - Black
  - White
3. Press **ENTER**.

## Setting up password protection

Protect your projector with a password. Once enabled, you must enter the password before you can project an image.

1. Select **Menu > Configuration > Menu Preferences > PIN Protect**.
2. Enter a password by number keys.
3. To confirm the password, select **OK**.

## Changing password

Change the current password to a new password.

1. Select **Menu > Configuration > Menu Preferences > Change PIN**.
2. Enter current password by number keys.
3. Select **OK**.
4. Enter new password by number keys.
5. Select **OK**.
6. To confirm the password, enter new password again by number keys.
7. Select **OK**.

## Setting up power mode

Adjust various projector's power settings including the shutdown time, sleep timer, and standby mode.

### Setting the standby mode

Determine which standby mode the projector is in when AC power on.

1. Select **Menu > Configuration > Power Management > Standby Mode**.
2. Select the appropriate mode:
  - **0.5W mode**—Less power consumption which does not have the ability to monitor the projector over a network cable.
  - **Communication mode**—More power consumption in standby mode which allows you to monitor the projector over a network cable.
3. Press **ENTER**.



Communication mode is the projector's default standby mode. After performing factory reset, manually set the standby mode to 0.5W mode to have less power consumption (<0.5W).

### Setting the AC power

Enable or disable this function to power on the projector directly or not when AC power is on.

1. Select **Menu > Configuration > Power Management > AC Power On**.
2. To swap, press **ENTER**.

### Setting the time for auto shutdown

Set up a time for automatically turns off the projector after no signal is detected for a preset number of minutes. If an active signal is received before the projector powers down, the image is displayed.

1. Select **Menu > Configuration > Power Management > Auto Shutdown**.
2. Select the appropriate time to automatically turn off the projector when there is no signal.
3. To confirm the selection, press **ENTER**.

### Setting the sleep timer

Set up a time for automatically power off the projector, after it has been on for a specified amount of time.

1. Select **Menu > Configuration > Power Management > Sleep Timer**.
2. Select the appropriate time to automatically turn off the projector.
3. To confirm the selection, press **ENTER**.

## Enabling the 12V Trigger

The 12V trigger is used for electrical projector screens. The projector screen is automatically lowered or raised when the projector is switched on or off.

1. Select **Menu > Configuration > 12V Trigger**.
2. To swap, press **ENTER**.

## Enabling high altitude setting

Enable high altitude mode when altitudes  $\geq$  2000 m. The fan operates at high speed to ensure sufficient air flow for high altitudes; however, the noise level of the projector is increased.

1. Select **Menu > Configuration > High Altitude**.
2. To swap, press **ENTER**.

## Adjusting the back light settings

Control the back light behavior and timeout setting for the keypad and status LED.

1. Select **Menu > Configuration > Backlight Preferences > Keypad Backlight**.
2. Select the appropriate setting for keypad backlight.
3. To confirm the selection, press **ENTER**.
4. Select **Menu > Configuration > Backlight Preferences > Status LED**.
5. Select the appropriate setting for status LED.
6. To confirm the selection, press **ENTER**.

## Setting the hot key

To directly call out a function without going through the layers of the on-screen display (OSD) menus, select a specific function for a hot key. To access this function, press **HOT KEY** on the remote control.

1. Select **Menu > Configuration > Hot-Key Settings**.
2. Select the one function for the hot key:
  - Size Presets
  - Picture Settings
  - Default Value
  - Detail
  - Contrast Enhancement
  - Light Source Mode

- Image Freeze
- Information
- Disable Warp/Blend

3. To set the selected function as the hot key, press **ENTER**.



When the hot key is set to Disable Warp/Blend, pressing the hot key once disables the currently applied warp and blend. Pressing the hot key again enables the function and returns the warp and blend to the screen.

# Configuring communications

Define and control how single or multiple projectors are linked with each other and with controlling device.

## Setting the projector communication

Enable the receivers and the wired keypad to communicate with the projector from the remote. The front and top IR sensors receive transmissions from the IR remote. Keep the transmission path to these sensors unobstructed for uninterrupted communications with the projector.

1. Select **Menu > Configuration > IR Control**.
2. To enable the front IR sensor, check **Front**.
3. To confirm the selection, press **ENTER**.
4. To enable the top IR sensor, check **Top**.
5. To confirm the selection, press **ENTER**.
6. To enable the signal from the HDBaseT Box, check **HDBaseT**.
7. To confirm the selection, press **ENTER**.
8. To set the projector address, select **Menu > Configuration > Communications > Projector Address**.
9. Select specific number for this projector from 0 to 9. The projector responds to the IR remote set to the same address as the projector or to the IR remote set to address 0.
10. To match up with the projector address, press **PROJ** and specific number key.

## Setting network environment

Determine the communication settings such as network setup, serial port information, and so on.

### Adjusting LAN setting

Set up network configuration for wire networking.

1. Select **Menu > Configuration > Communications > LAN**.
2. Set up the appropriate setting:
  - **Mac Address**—Display the network MAC address value.
  - **DHCP**—Enable or disable the DHCP to automatically get IP address, subnet mask, and so on.
  - **IP Address**—Assign the network IP address.
  - **Subnet Mask**—Assign the network subnet mask.
  - **Default Gateway**—Assign the network default gateway.
  - **Primary DNS**—Assign the primary DNS.
  - **Secondary DNS**—Assign the secondary DNS.
3. To apply the LAN settings, select **Apply**.

### Adjusting WLAN setting

Set up network configuration for wireless networking.

1. Select **Menu > Configuration > Communications > WLAN**.
2. Set up the appropriate setting:
  - **SSID**—Display the SSID of the wireless network.
  - **Enable**—Enable or disable the wireless functionality.
  - **Start IP**—Assign the start IP address of the wireless network.
  - **End IP**—Assign the end IP address of the wireless network.
  - **Subnet Mask**—Assign the subnet mask of the wireless.
  - **Default Gateway**—Assign the gateway of the wireless.
3. To apply the WLAN settings, select **Apply**.

## Adjusting network setting

Set up network configuration setting, such as reset back to default.

1. Select **Menu > Configuration > Communications > Network**.
2. Set up the appropriate network setting:
  - **Show Network Message**—Enable or disable to display of the network message.
  - **Reset to Default**—Reset the network configuration setting, including LAN setting and WLAN setting, back to default.
3. To apply the network configuration, press **ENTER**.

## Setting serial port baud rate

Select the serial port and baud rate.

1. Select **Menu > Configuration > Communications > Serial Port Baud rate**.
2. Set up the appropriate baud rate.
3. To confirm the selection, press **ENTER**.

## Enabling serial port echo

Enable or disable to allow the CLI command pass through.

1. Select **Menu > Configuration > Communications > Serial Port Echo**.
2. To swap, press **ENTER**.

## Setting serial port path

Set the serial port path to allow the command pass through RS232 or HDBaseT.

1. Select **Menu > Configuration > Communications > Serial Port Path**.
2. Select the appropriate serial port path.
3. To confirm the selection, press **ENTER**.

## Using web user interface

The web user interface provides an alternate way to access the menu functionality on the projector. You can log on to the web user interface from a computer or mobile devices.

### System requirements

To use the web user interface, make sure your devices and software meet the minimum system requirements.

Minimum system requirements	
Hardware	<ul style="list-style-type: none"> <li>• Projector</li> <li>• Power cord, provided with the projector and appropriately rated for your region</li> <li>• RJ45 cable (CAT-5e) or wireless dongle</li> <li>• PC, laptop, mobile phone, or tablet installed with a web browser</li> </ul>
Software	<ul style="list-style-type: none"> <li>• Firmware upgrade program</li> <li>• Web browser               <ul style="list-style-type: none"> <li>• Internet Explorer 11</li> <li>• Microsoft Edge 40</li> <li>• Firefox 57</li> <li>• Chrome 63</li> <li>• Safari 11</li> </ul> </li> <li>• Operating system of mobile devices               <ul style="list-style-type: none"> <li>• iOS 10</li> <li>• Android 5</li> </ul> </li> </ul>

### Logging on to the web user interface

Log on to the web user interface by following the steps below.

1. Connect the projector to AC and power it on.
2. When network is available, connect the projector and computer to the same network.
  - a. To check the projector address in a wired network, select **Menu > Configuration > Communications > LAN > IP Address**.
  - b. To check the projector address in a wireless network, select **Menu > Configuration > Communications > WLAN > Default Gateway**.
3. If network is unavailable, connect the projector to the computer with an RJ45 cable.
  - a. Set the Default Gateway and Subnet Mask of the computer to match the projector.
  - b. Set the IP address of the computer to match the first three numbers of the projector.  
For example, if the projector IP address is 192.168.000.100, set the computer IP address to 192.168.000.xxx, where xxx is not 100.
4. Open a web browser and type the projector address in the browser address bar.
5. In the Username field, type the username.



6. In the Password field, type the password.
7. Click **Login**.

## Setting the system notification

Configure the Simple Network Management Protocol (SNMP) settings for receiving notifications from the system directly to the email. SNMP provides network administrators with a common way to manage their network devices from a single remote location. Administrators can use the SNMP interface to query a number of devices to see their current status or configuration. Operators can change configuration values and configure trap notifications to be sent when certain events occur (for example, loss of signal, power state change, and so on).

Emails are sent to the mail server configured in the projector settings. Up to two user email accounts can be selected. Important information regarding the event is located in the body content of the email.

SNMP traps are notifications that are sent from the projector. They are only received by a trap receiver (MIB Browser) in the computer.

1. From the web user interface, select **Network > Notification**.  
See [Using web user interface](#) on page 56 for further information.
2. Set up the appropriate SNMP setting:
  - **SNMP Read Community**—Plain text password that must also be entered in the MIB browser. This password allows various settings in the projector to be queried.
  - **SNMP Location**—Use as a description to where a projector is located in a building. SNMP emails sent specify this location.
  - **Trap IP Address**—Fill in this field with the IP address of the computer, on which you want to view received traps from the projector.
  - **Sender Email**—Set the email account as the source of the system notifications.
  - **SMTP Server**—Enter the IP address of the mail server.
  - **Recipient**—Enter up to two email accounts to receive the system notification.
3. Set the SNMP actions for the system events:
  - **Disabled**—Disable email notification
  - **SNMP Trap**—Send the notification to the trap receiver (MIB Browser).
  - **Email**—Send the notification to the email recipient.
  - **SNMP Trap and Email**—Send the notification to the trap receiver and the email recipient.
4. To apply the notification settings, click **Save**.

# Configuring input settings

Learn how to configure the input source and picture in picture (PIP)/picture by picture (PBP) settings.

## Setting main input source

Set up the active input to be used as the main image.

1. Select **Menu > Input Switching & PIP > Main Input**.
2. To select the active input, press **ENTER**.

## Setting second input source

Select an active input to be used as the picture in picture (PIP)/picture by picture (PBP).

1. Select **Menu > Input Switching & PIP > PIP/PBP Input**.
2. To select another active input, press **ENTER**.

## Enabling second input source

To activate the picture in picture (PIP)/picture by picture (PBP) setting, switch on this function.

1. Select **Menu > Input Switching & PIP > PIP/PBP Enable**.
2. To swap, press **ENTER**.

## Swapping main input and second input source

Switch the main input source with second input source.

1. Select **Menu > Input Switching & PIP > Swap**.
2. To swap, press **ENTER**.

## Setting the size of second input source

Set the size of picture in picture (PIP)/picture by picture (PBP). See *Input sources layout and size* on page 59 for further details of the layout and size.

1. Select **Menu > Input Switching & PIP > Size**.
2. Select the appropriate size, small, medium or large, for PIP/PBP input source.
3. To confirm the selection, press **ENTER**.

## Setting up the display layout with two input sources







Set the display location for main input source and second input source on the screen. See *Input sources layout and size* on page 59 for further details of the layout and size.

1. Select **Menu > Input Switching & PIP > Main Layout**.
2. Select the appropriate layout.
3. To confirm the selection, press **ENTER**.

### Input sources layout and size

A P indicates the primary source region (lighter color) and an asterisk (\*) indicates both regions are the same size.

PIP/PBP Layout	PIP/PBP Size		
	Small	Medium	Large
PBP, Main Left			
PBP, Main Top			
PBP, Main Right			
PBP, Main Bottom			
PIP, Bottom Right			
PIP, Bottom Left			

PIP/PBP Layout	PIP/PBP Size		
	Small	Medium	Large
PIP, Top Left			
PIP, Top Right			

## Setting the timing detection mode

Set timing detection mode to wide or normal to support additional PC timings. When the projected picture is not completed, this function is used to adjust the picture.

1. Select **Menu > Input Switching & PIP > Auto Image**.
2. Select the appropriate mode:
  - **Normal mode**—Supports 4:3 input sources.
  - **Wide mode**—Supports the 16:9 input source and most 4:3 input sources.

For 4:3 input sources not recognized by Wide mode (for example 1400 x 1050), perform Auto Image using Normal mode.
3. To confirm the selection, press **ENTER**.

## Setting the input searching method

Set the most suited method for searching input source.

1. Select **Menu > Input Switching & PIP > Input key**.
2. Select the appropriate searching method:
  - **Change Sources**—Change the source manually by pressing **INPUT** on the keypad or remote control.
  - **List all Sources**—Select to list all the sources and then select the input source you want.
  - **Auto Sources**—Automatically search the source.
3. To confirm the selection, press **ENTER**.

## Blanking the screen for signal switch

Blanks the screen before timing is stable when changing the source.

1. Select **Menu > Input Switching & PIP > Blank on Signal Switch**.
2. To swap, press **ENTER**.

# Configuring light settings

Learn how to configure the light settings.

## Setting light source mode

Set up light source mode depending the environment.

1. Select **Menu** > **Light Source** > **Light Source Mode**.
2. Select appropriate light source mode:
  - **Constant Power**—Enable Constant Power to set the projector brightness to a specific level controlled by the laser diode power. See [Adjusting the light power](#) on page 62 for further details of setting the laser diode power.
  - **Constant Intensity**—After enabling Constant Power, select Constant Intensity to maintain current constant brightness and color settings. This function can remain at current setting for longer period of time than Constant Power mode.

Note:

- Light sensor calibration must be performed before enabling Constant Intensity.
  - This mode is used for long term projecting or blending purpose.
  - When Constant Intensity is enabled, Dynamic Black and Real Black functions are automatically disabled.
  - When Picture Settings is changed under Constant Intensity, light source mode automatically changes back to Constant Power.
  - **ECO 1**—Set the projector to 80% constant brightness and color settings.
  - **ECO 2**—Set the projector to 50% constant brightness and color settings.
  - **Rental Mode**—Remain at 80% constant brightness and color settings. Light sensor calibration must be performed before enabling Rental Mode.
3. Press **ENTER**.

## Adjusting the light power

Set the value of the laser diode power. The power levels can be managed to obtain the brightest picture or longest light source life. The minimum setting of the light power is 30% brightness and color setting, and the maximum is 100% brightness and color setting.

1. Select **Menu > Light Source > Constant Power**.
2. Adjust the slider by arrow keys or press **ENTER** to input the value you selected.
3. After inputting the value, press **ENTER** to apply.

## Calibrating the light sensor

Light brightness decays naturally over time, so use this system to maintain the correct color point. Set the time for light calibration.

1. Select **Menu > Light Source > Light Sensor Calibration**.
2. Select most suited time for doing the light sensor calibration:
  - **Default**—Process light calibration at the cooling stage.
  - **Manual**—Select to perform light calibration manually.
3. To confirm the selection, press **ENTER**.

# Diagnostic tools

Follow these procedures to help diagnose issues with HS Series 2K projectors.

## Viewing projector information

View the status of the projector, source information, light source information, and communication information. The information is read-only.

1. To view the status of the projector, such as model name, serial number, and so on, select **Menu > Information > Status Info**.
2. To view source information, such as signal format, resolution, and so on, select **Menu > Information > Source Info**.
3. To view the communication information, such as projector's IP address, subnet, and so on, select **Menu > Information > Communications Info**.
4. To view the light source information, such as total projector hours and laser diode (LD) hours, select **Menu > Information > Light Source Info**.
5. To view the firmware information, such as software version, LAN version, and so on, select **Menu > Information > Firmware Version Info**.

## Selecting a test pattern

Use the projector's test patterns to assist with configuration of the projector and to diagnose any issues that may occur.

1. Select Test Pattern on remote control.  
You can also select the test patterns from **Menu > Test Pattern**.
2. Scroll through the list of test patterns by left and right arrow keys on remote control.
3. Select the required test pattern.
4. To confirm your selection, press **ENTER**.

## Restoring factory default settings

Restoring factory settings removes all custom device settings.



To avoid warranty violation, only Christie qualified technicians can reset factory defaults.

1. Select **MENU** > **Configuration** > **Service**.
2. Enter the service password.
3. Select **Factory Reset**.

All customized settings are set to the default factory settings.

4. At the confirmation prompt, select **OK**.



# Signal connectivity specifications

Identify the signal connectivity specifications for HS Series 2K projectors.

The list of formats listed below are not exhaustive and other formats may be supported. For more information, contact Christie Technical Support.

## VGA video formats

Identify the video formats for the VGA input.

Signal Type	Format	Hres	Vres	Frame rate (Hz)	Sampling	Bit-Depth
PC	640x480	640	480	60,72,75,85,66.6	RGB	8bpc
	800x600	800	600	60,72,75,85,120	RGB	8bpc
	832x624	832	624	75	RGB	8bpc
	1024x768	1024	768	60,75,85,120	RGB	8bpc
	1152x864	1152	864	60,70,75,85	RGB	8bpc
	1280x720	1280	720	50,60,75,85,120	RGB	8bpc
	1280x768	1280	768	60,75,85	RGB	8bpc
	1280x800	1280	800	50,60,75,85	RGB	8bpc
	1280x960	1280	960	60,75,85	RGB	8bpc
	1280x1024	1280	1024	60,75,85	RGB	8bpc
	1368x768	1368	768	60	RGB	8bpc
	1400x1050	1400	1050	75	RGB	8bpc
	1440x900	1440	900	60	RGB	8bpc
	1600x1200	1600	1200	60	RGB	8bpc
	1920x1080	1920	1080	50,60	RGB	8bpc
1920x1200RB	1920	1920	50,60	RGB	8bpc	
SDTV	480i			60	RGB	8bpc
	576i			50	RGB	8bpc

Signal Type	Format	Hres	Vres	Frame rate (Hz)	Sampling	Bit-Depth
EDTV	480p			60	RGB	8bpc
	576p			50	RGB	8bpc
HDTV	1080i			25,29,30	RGB	8bpc
	720p			50,59,60	RGB	8bpc
	1080p			23,24,25,29,30,50,59,60	RGB	8bpc

## HDMI video formats

Identify the video formats for the HDMI input.

Signal Type	Format	Hres	Vres	Frame rate (Hz)	Sampling	Bit-Depth
PC	640x480	640	480	60,72,75,85,66.6	RGB/4:4:4/4:2:2	8/10/12bpc
	800x600	800	600	60,72,75,85,120	RGB/4:4:4/4:2:2	8/10/12bpc
	832x624	832	624	75	RGB/4:4:4/4:2:2	8/10/12bpc
	848x480	848	480	50,60,75,85	RGB/4:4:4/4:2:2	8/10/12bpc
	1024x768	1024	768	60,75,85,120	RGB/4:4:4/4:2:2	8/10/12bpc
	1152x864	1152	864	60,70,75,85	RGB/4:4:4/4:2:2	8/10/12bpc
	1152x870	1152	870	75	RGB/4:4:4/4:2:2	8/10/12bpc
	1280x720	1280	720	50,60,75,85,120	RGB/4:4:4/4:2:2	8/10/12bpc
	1280x768	1280	768	60,75,85	RGB/4:4:4/4:2:2	8/10/12bpc
	1280x800	1280	800	50,60,75,85	RGB/4:4:4/4:2:2	8/10/12bpc
	1280x960	1280	960	50,60,75,85	RGB/4:4:4/4:2:2	8/10/12bpc
	1280x1024	1280	1024	50,60,75,85	RGB/4:4:4/4:2:2	8/10/12bpc
	1360x768	1360	768	50,60,75,85	RGB/4:4:4/4:2:2	8/10/12bpc
	1368x768	1368	768	60	RGB/4:4:4/4:2:2	8/10/12bpc
	1400x1050	1400	1050	50,60,75	RGB/4:4:4/4:2:2	8/10/12bpc
	1440x900	1440	900	60,75	RGB/4:4:4/4:2:2	8/10/12bpc
	1600x900	1600	900	60	RGB/4:4:4/4:2:2	8/10/12bpc
	1600x1200	1600	1200	60	RGB/4:4:4/4:2:2	8/10/12bpc
1920x1080	1920	1080	50,60	RGB/4:4:4/4:2:2	8/10/12bpc	
1920x1200RB	1920	1920	50,60	RGB/4:4:4/4:2:2	8/10/12bpc	
SDTV	480i			60	RGB/4:4:4/4:2:2	8/10/12bpc
	576i			50	RGB/4:4:4/4:2:2	8/10/12bpc
EDTV	480p			60	RGB/4:4:4/4:2:2	8/10/12bpc
	576p			50	RGB/4:4:4/4:2:2	8/10/12bpc

Signal Type	Format	Hres	Vres	Frame rate (Hz)	Sampling	Bit-Depth
HDTV	1080i			25,29,30	RGB/4:4:4/4:2:2	8/10/12bpc
	720p			50,59,60	RGB/4:4:4/4:2:2	8/10/12bpc
	1080p			23,24,25,29,30,50,59,60	RGB/4:4:4/4:2:2	8/10/12bpc
Mandatory 3D	Frame Packing 1080p			24	RGB/4:4:4/4:2:2	8/10/12bpc
	Frame Packing 720p			50,60	RGB/4:4:4/4:2:2	8/10/12bpc
	Top and Bottom 720p			50,60	RGB/4:4:4/4:2:2	8/10/12bpc
	Top and Bottom 1080p			24	RGB/4:4:4/4:2:2	8/10/12bpc
	Side by Side 1080i			25,30	RGB/4:4:4/4:2:2	8/10/12bpc
Frame Sequential 3D	800x600			120	RGB/4:4:4	8bpc
	1024x768			120	RGB/4:4:4	8bpc
	1280x720			120	RGB/4:4:4	8bpc
	1920x1080			120	RGB/4:4:4	8bpc
	1920x1080			60	RGB/4:4:4	8bpc
	1920x1200RB			60	RGB/4:4:4	8bpc
4K	3840x2160	3840	2160	23,24,25,29,30,50,59,60	RGB/4:4:4	8bpc
	4096x2160	4096	2160	23,24,25,29,30,50,59,60	RGB/4:4:4	8bpc

## DVI video formats

Identify the video formats for the DVI input.

Signal Type	Format	Hres	Vres	Frame rate (Hz)	Sampling	Bit-Depth
PC	640x480	640	480	60,72,75,85,66.6	RGB/4:4:4/4:2:2	8/10/12bpc
	800x600	800	600	60,72,75,85,120	RGB/4:4:4/4:2:2	8/10/12bpc
	832x624	832	624	75	RGB/4:4:4/4:2:2	8/10/12bpc
	848x480	848	480	50,60,75,85	RGB/4:4:4/4:2:2	8/10/12bpc
	1024x768	1024	768	60,75,85,120	RGB/4:4:4/4:2:2	8/10/12bpc
	1152x864	1152	864	60,70,75,85	RGB/4:4:4/4:2:2	8/10/12bpc
	1152x870	1152	870	75	RGB/4:4:4/4:2:2	8/10/12bpc
	1280x720	1280	720	50,60,75,85,120	RGB/4:4:4/4:2:2	8/10/12bpc
	1280x768	1280	768	60,75,85	RGB/4:4:4/4:2:2	8/10/12bpc
1280x800	1280	800	50,60,75,85	RGB/4:4:4/4:2:2	8/10/12bpc	

Signal Type	Format	Hres	Vres	Frame rate (Hz)	Sampling	Bit-Depth
PC	1280x960	1280	960	50,60,75,85	RGB/4:4:4/4:2:2	8/10/12bpc
	1280x1024	1280	1024	50,60,75,85	RGB/4:4:4/4:2:2	8/10/12bpc
	1360x768	1360	768	50,60,75,85	RGB/4:4:4/4:2:2	8/10/12bpc
	1368x768	1368	768	60	RGB/4:4:4/4:2:2	8/10/12bpc
	1400x1050	1400	1050	50,60,75	RGB/4:4:4/4:2:2	8/10/12bpc
	1440x900	1440	900	60,75	RGB/4:4:4/4:2:2	8/10/12bpc
	1600x900	1600	900	60	RGB/4:4:4/4:2:2	8/10/12bpc
	1600x1200	1600	1200	60	RGB/4:4:4/4:2:2	8/10/12bpc
	1920x1080	1920	1080	50,60	RGB/4:4:4/4:2:2	8/10/12bpc
	1920x1200RB	1920	1920	50,60	RGB/4:4:4/4:2:2	8/10/12bpc
SDTV	480i			60	RGB/4:4:4/4:2:2	8/10/12bpc
	576i			50	RGB/4:4:4/4:2:2	8/10/12bpc
EDTV	480p			60	RGB/4:4:4/4:2:2	8/10/12bpc
	576p			50	RGB/4:4:4/4:2:2	8/10/12bpc
HDTV	1080i			25,29,30	RGB/4:4:4/4:2:2	8/10/12bpc
	720p			50,59,60	RGB/4:4:4/4:2:2	8/10/12bpc
	1080p			23,24,25,29,30,50,59,60	RGB/4:4:4/4:2:2	8/10/12bpc
Mandatory 3D	Frame Packing 1080p			24	RGB/4:4:4/4:2:2	8/10/12bpc
	Frame Packing 720p			50,60	RGB/4:4:4/4:2:2	8/10/12bpc
	Top and Bottom 720p			50,60	RGB/4:4:4/4:2:2	8/10/12bpc
	Top and Bottom 1080p			24	RGB/4:4:4/4:2:2	8/10/12bpc
	Side by Side 1080i			25,30	RGB/4:4:4/4:2:2	8/10/12bpc
Frame Sequential 3D	800x600			120	RGB/4:4:4	8bpc
	1024x768			120	RGB/4:4:4	8bpc
	1280x720			120	RGB/4:4:4	8bpc
	1920x1080			120	RGB/4:4:4	8bpc
	1920x1080			60	RGB/4:4:4	8bpc
	1920x1200RB			60	RGB/4:4:4	8bpc
4K	3840x2160	3840	2160	23,24,25,29,30,50,59,60	RGB/4:4:4	8bpc
	4096x2160	4096	2160	23,24,25,29,30,50,59,60	RGB/4:4:4	8bpc

## HDBaseT video formats

Identify the video formats for the HDBaseT input.

Signal Type	Format	Hres	Vres	Frame rate (Hz)	Sampling	Bit-Depth
PC	640x480	640	480	60,72,75,85,66.6	RGB/4:4:4/4:2:2	8bpc
	800x600	800	600	60,72,75,85,120	RGB/4:4:4/4:2:2	8bpc
	832x624	832	624	75	RGB/4:4:4/4:2:2	8bpc
	848x480	848	480	50,60,75,85	RGB/4:4:4/4:2:2	8bpc
	1024x768	1024	768	60,75,85,120	RGB/4:4:4/4:2:2	8bpc
	1152x864	1152	864	60,70,75,85	RGB/4:4:4/4:2:2	8bpc
	1152x870	1152	870	75	RGB/4:4:4/4:2:2	8bpc
	1280x720	1280	720	50,60,75,85,120	RGB/4:4:4/4:2:2	8bpc
	1280x768	1280	768	60,75,85	RGB/4:4:4/4:2:2	8bpc
	1280x800	1280	800	50,60,75,85	RGB/4:4:4/4:2:2	8bpc
	1280x960	1280	960	50,60,75,85	RGB/4:4:4/4:2:2	8bpc
	1280x1024	1280	1024	50,60,75,85	RGB/4:4:4/4:2:2	8bpc
	1360x768	1360	768	50,60,75,85	RGB/4:4:4/4:2:2	8bpc
	1368x768	1368	768	60	RGB/4:4:4/4:2:2	8bpc
	1400x1050	1400	1050	50,60,75	RGB/4:4:4/4:2:2	8bpc
	1440x900	1440	900	60,75	RGB/4:4:4/4:2:2	8bpc
	1600x900	1600	900	60	RGB/4:4:4/4:2:2	8bpc
	1600x1200	1600	1200	60	RGB/4:4:4/4:2:2	8bpc
1920x1080	1920	1080	50,60	RGB/4:4:4/4:2:2	8bpc	
1920x1200RB	1920	1920	50,60	RGB/4:4:4/4:2:2	8bpc	
SDTV	480i			60	RGB/4:4:4/4:2:2	8bpc
	576i			50	RGB/4:4:4/4:2:2	8bpc
EDTV	480p			60	RGB/4:4:4/4:2:2	8bpc
	576p			50	RGB/4:4:4/4:2:2	8bpc
HDTV	1080i			25,29,30	RGB/4:4:4/4:2:2	8bpc
	720p			50,59,60	RGB/4:4:4/4:2:2	8bpc
	1080p			23,24,25,29,30,50,59,60	RGB/4:4:4/4:2:2	8bpc

Signal Type	Format	Hres	Vres	Frame rate (Hz)	Sampling	Bit-Depth
Mandatory 3D	Frame Packing 1080p			24	RGB/4:4:4/4:2:2	8bpc
	Frame Packing 720p			50,60	RGB/4:4:4/4:2:2	8bpc
	Top and Bottom 720p			50,60	RGB/4:4:4/4:2:2	8bpc
	Top and Bottom 1080p			24	RGB/4:4:4/4:2:2	8bpc
	Side by Side 1080i			25,30	RGB/4:4:4/4:2:2	8bpc
Frame Sequential 3D	800x600			120	RGB/4:4:4	8bpc
	1024x768			120	RGB/4:4:4	8bpc
	1280x720			120	RGB/4:4:4	8bpc
	1920x1080			60	RGB/4:4:4	8bpc
	1920x1200RB			60	RGB/4:4:4	8bpc
4K	3840x2160	3840	2160	23,24,25,29,30	RGB/4:4:4	8bpc
	4096x2160	4096	2160	23,24,25,29,30	RGB/4:4:4	8bpc

## 3G-SDI video formats

Identify the video formats for the 3G-SDI input.

Signal Type	Format	Hres	Vres	Frame rate (Hz)	Sampling	Bit-Depth
SD-SDI	480i			60	4:2:2	10bpc
	576i			50	4:2:2	10bpc
HD-SDI	720p			50,59,60	4:2:2	10bpc
	1080i			25,29,30	4:2:2	10bpc
	1080p			23,24,25,29,30	4:2:2	10bpc
	1080sF			23,24,25,29,30	4:2:2	10bpc
3GA-SDI	1080p			50,59,60	4:2:2	10bpc
3GB-SDI	1080p With 352M Payload ID			50,59,60	4:2:2	10bpc

## Picture-in-picture/picture-by-picture (PIP/PBP) compatibility

The following table details the picture-in-picture/picture-by-picture (PIP/PBP) compatibility.

PIP/PBP Matrix	VGA	DVI	HDMI 1	HDMI 2	3G-SDI	HDBaseT
VGA		•	•	•	•	•
DVI	•		•	•	•	•
HDMI1	•	•		•	•	•
HDMI2	•	•	•		•	•
3G-SDI	•	•	•	•		•
HDBaseT	•	•	•	•	•	

- Dot (•): PIP/PBP combinations are enabled.

# Regulatory

This product conforms to the following regulations related to product safety, environmental requirements and electromagnetic compatibility (EMC).

## Safety

- CAN/CSA C22.2 No. 60950-1-07 – Information Technology Equipment – Safety – Part 1: General Requirements
- ANSI/UL 60950-1-2014 – Information Technology Equipment – Safety – Part 1: General Requirements
- IEC/EN 60950-1 – Information Technology Equipment – Safety – Part 1: General Requirements

## Laser safety

- IEC 60825-1 – Safety of Laser Products – Part 1: Equipment Classification and Requirements
- IEC/EN 62471-5 - Photobiological safety of lamps and lamp systems – Part 5: Image projectors
- FDA CDRH 21CFR 1040 - Performance Standards For Light-Emitting Products

## Electro-magnetic compatibility

### Emissions

- FCC CFR47, Part 15, Subpart B, Class A - Unintentional Radiators
- CAN ICES-3 (A/B) / NMB-3 (A) - Information Technology Equipment (Including Digital Apparatus)
- CISPR 32:2014/EN 55032:2014, Class A - Information Technology Equipment
- IEC 61000-3-2/EN61000-3-2 - Limits for Harmonic Current Emissions
- IEC 61000-3-3/EN61000-3-3 - Limitations of Voltage Changes, Voltage Fluctuations, and Flicker

### Immunity

- CISPR 24/EN55024 EMC Requirements - Information Technology Equipment



## Environmental

- EU Directive (2011/65/EU) on the restriction of the uses of certain hazardous substances (RoHS) in electrical and electronic equipment and the applicable official amendment(s)
- EU Directive (2012/19/EU) on waste and electrical and electronic equipment (WEEE) and the applicable official amendment(s)
- Regulation (EC) No 1907/2006 concerning the Registration, Evaluation, Authorization and Restriction of Chemicals (REACH) and the applicable official amendment(s)
- China Ministry of Information Industry Order No.39 (02/2006) on the control of pollution caused by electronic information products, hazardous substances concentration limits (SJ/T11363-2006), and the applicable product marking requirement (SJ/T11364-2006)

## Corporate offices

---

Christie Digital Systems USA, Inc.  
Cypress  
ph: 714 236 8610

Christie Digital Systems Canada Inc.  
Kitchener  
ph: 519 744 8005

## Worldwide offices

---

Australia  
ph: +61 (0) 7 3624 4888

Brazil  
ph: +55 (11) 2548 4753

China (Beijing)  
ph: +86 10 6561 0240

China (Shanghai)  
ph: +86 21 6278 7708

France  
ph: +33 (0) 1 41 21 44 04

Germany  
ph: +49 2161 664540

India  
ph: +91 (080) 6708 9999

Japan (Tokyo)  
ph: 81 3 3599 7481

Korea (Seoul)  
ph: +82 2 702 1601

Mexico  
ph: +52 55 4744 1790

Republic of South Africa  
ph: +27 (0)11 510 0094

Russian Federation  
and Eastern Europe  
ph: +36 (0) 1 47 48 100

Singapore  
ph: +65 6877 8737

Spain  
ph: +34 91 633 9990

United Arab Emirates  
ph: +971 4 3206688

United Kingdom  
ph: +44 (0) 118 977 8000

United States (Arizona)  
ph: 602 943 5700

United States (New York)  
ph: 646 779 2014

## Independant sales consultant offices

Italy  
ph: +39 (0) 2 9902 1161



For the most current technical documentation, visit [www.christiedigital.com](http://www.christiedigital.com).

